

EXECUTIVES

dvo_

A LIFEFUL PLACE FOR A DESIGNFUL INSTINCT

Design del servizio. Siamo prima di tutto questo. Esperti del settore dell'arredo da ufficio. E innovatori. Partner prima che fornitori. Partecipiamo ai progetti dei clienti fornendo servizi di pre e post-vendita e formazione continua. Puntiamo alla felicità del cliente perché è un concetto che va oltre la semplice soddisfazione. Siamo una service company che risponde a ogni idea creativa con un servizio just in time e una logistica veloce e affidabile. Lavoriamo al fianco di architetti e progettisti per fornire un servizio flessibile, dinamico, a misura di cliente e di progetto. Pensiamo e agiamo "green", implementando continuamente le nostre certificazioni. DVO è soprattutto questo. Un partner capace di interpretare il mercato e comprenderne le evoluzioni. Per fornire le risposte giuste prima che diventino bisogni.

Service design. This is what we are, first and foremost. Experts in the office furniture industry. And innovators. Partners more so than suppliers. We contribute to our customers' projects, providing before- and after-sales services and continuous training. We strive to make our customers happy, because happiness goes well beyond satisfaction. We are a service company that responds to every creative idea with a just-in-time strategy and fast, reliable logistics. We work alongside architects and designers to offer a flexible, dynamic service tailored to the customer and the project. We think and act "green", continuously building on our certifications. DVO is this, above all. A partner able to interpret the market and understand its evolution. To give the right answers before desires become needs.

Executives

“Le prestigiose collezioni di mobili e scrivanie per lo spazio ufficio direzionale.”

Una vasta gamma di prodotti e soluzioni che si adattano perfettamente ad ogni esigenza: minimalismo, ricerca del dettaglio, preziosità dei materiali, eleganza e originalità.

Prestigious executive collections for executives space.

A wide range of products and solutions for any need: minimalist style, detail research, precious materials, elegance and originality.

Vigo P. 04



Noto P. 32



Tokio P. 50



Rym P. 58



Rodi P. 76



Tay P. 82



Vertigo P. 98

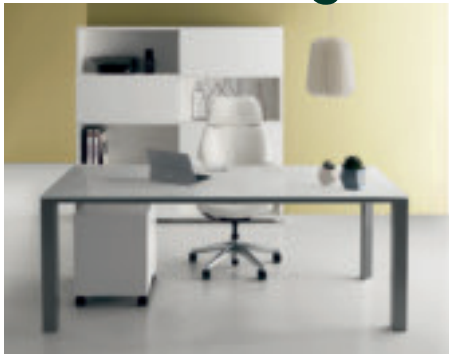

Planeta P. 120



Oxford P. 140



Vigo

DV913

È un sistema d'arredo direzionale concepito per conferire decisa e peculiare personalità allo spazio ufficio, un habitat professionale all'insegna della tecnologia e del comfort, nonché flessibile e aperto agli spazi condivisi.

Is an executive furnishing collection designed to give a strong and distinctive personality to the office space, a professional habitat characterized by technology and comfort, flexible and open to common areas.



Executives





Executives





Executives









Executives





Executives





Executives





Le strutture dei tavoli mettono in evidenza la particolare composizione tra la gamba portante e il telaio in alluminio.

The structures of the tables highlight the particular composition between the supporting leg and the aluminum frame.

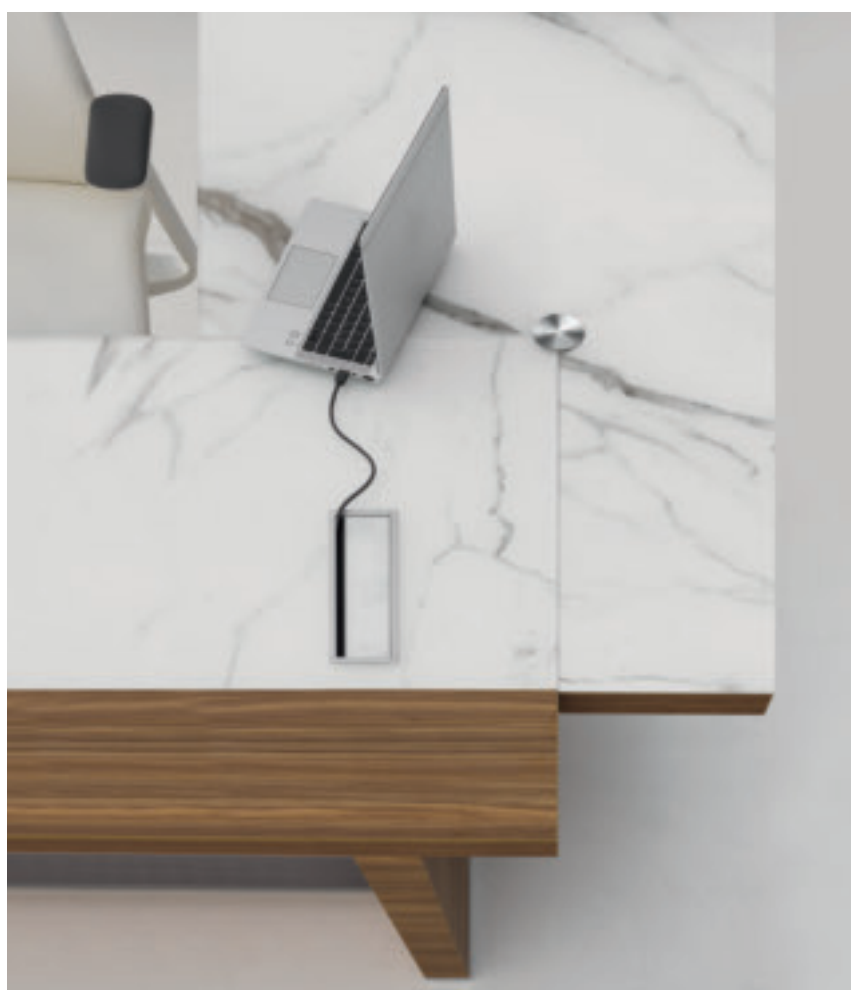









Executives









Vigo accoglie un piano supplementare rotondo in appoggio, per ospitare temporaneamente collaboratori oppure organizzare riunioni ristrette.

Vigo accommodates an additional round top in support, to temporarily accommodate collaborators or organize small meetings.

Executives



Tavoli / Tables

Piani di lavoro sp. 5 cm, in melaminico / Worktops 5 cm thick, in melamine



NM Noce "Maroncelli" / "Maroncelli" walnut
RC Rovere chiaro / Light oak

Piani superiori in melaminico sp. 1 cm, piani composti lato visitatore / Melamine upper worktops 1 cm thick, compound worktops customer side



NM Noce "Maroncelli" / "Maroncelli" walnut
RC Rovere chiaro / Light oak

Piani superiori in vetro serigrafato sp. 1 cm, piani composti lato operatore / Glass upper worktops 1 cm thick, compound worktops worker side

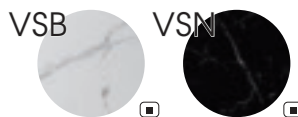

VSB Bianco / White
VSN Nero / Black

Gambe in folding sp. 10 cm / Legs in folding 10 cm thick



NM Noce "Maroncelli" / "Maroncelli" walnut
RC Rovere chiaro / Light oak
NO Nero opaco / Matt black

Modesty panel sp. 3 cm / Modesty panel 3 cm thick



NM Noce "Maroncelli" / "Maroncelli" walnut
RC Rovere chiaro / Light oak

Cassettiera sp. 1.8 cm per allungo a giorno / Drawer 1.8 cm thick for open extension table



NM Noce "Maroncelli" / "Maroncelli" walnut
RC Rovere chiaro / Light oak

Libreria / Bookshelf

Scocca libreria sp. 3 o 5 cm / Bookshelf body 3 or 5 cm thick



NM Noce "Maroncelli" / "Maroncelli" walnut
RC Rovere chiaro / Light oak

Ante a ribalta e schiena libreria sp. 1.8 cm / Bookshelf flap doors and back panel 1.8 cm thick



NM Noce "Maroncelli" / "Maroncelli" walnut
RC Rovere chiaro / Light oak
NO Nero opaco / Matt black

Strutture metalliche / Metal structures



W Bianco / White
H Alluminio / Aluminium
A Antracite / Anthracite

Note

□ Prodotti non in pronta consegna. Per la disponibilità contattare l'ufficio commerciale / Items not in prompt delivery. Please contact the commercial department to check availability.

Tavoli H. 75 cm con piani di lavoro interi in melaminico sp. 5 / Desk tables H.75 cm with whole worktops in melamine 5 cm thick

P 130 x H 75

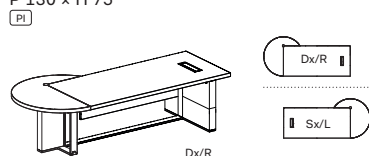

913.TS.61.26_ L 265 Dx/R - Sx/L
913.TS.61.28_ L 285 Dx/R - Sx/L

Tavoli scrivania con penisola
/ Desk tables with peninsula

P 220 x H 75

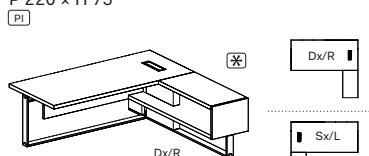

913.TM.36.20_ L 200 Dx/R - Sx/L
913.TM.36.22_ L 220 Dx/R - Sx/L

Tavoli con allungo a giorno
/ Tables with open extension

P 220 x H 75

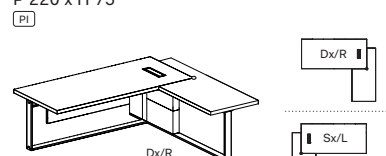

913.TM.46.23_ L 230 Dx/R - Sx/L
913.TM.46.25_ L 250 Dx/R - Sx/L

Tavoli con allungo laterale
/ Tables with lateral extension

Tavoli H. 76 cm con piani di lavoro sp. 6, composti da piani in melaminico sp. 5 più piani in melaminico o vetro sp. 1 / Desk tables H.76 with 6 cm thick worktops, composed of 5 cm th. melamine worktop plus 1 cm th. melamine or glass top

P 130 - H 76

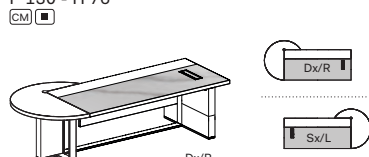

913.TS.62.26_ L 265 Dx/R - Sx/L
913.TS.62.28_ L 285 Dx/R - Sx/L

Tavoli scrivania con penisola
/ Desk tables with peninsula

P 220 x H 76

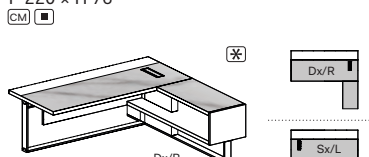

913.TM.37.20_ L 200 Dx/R - Sx/L
913.TM.37.22_ L 220 Dx/R - Sx/L

Tavoli con allungo a giorno
/ Tables with open extension

P 220 x H 76

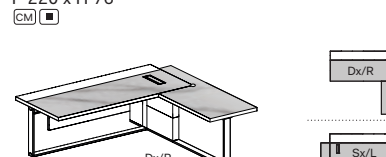

913.TM.47.23_ L 230 Dx/R - Sx/L
913.TM.47.25_ L 250 Dx/R - Sx/L

Tavoli con allungo laterale
/ Tables with lateral extension

Penisola H. 75 cm con piano in melaminico sp. 5 / Peninsula H.75 cm with melamine top 5 cm thick

Ø 130 x H 75

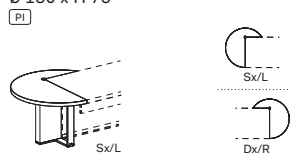

913.PE.01.13_ Dx/R - Sx/L

Penisola H. 76 cm con piano sp. 6 cm, composto da piani in melaminico sp. 5 + 1 cm / Peninsula H.76 cm with 6 cm thick top, composed of 5 cm + 1 cm th. melamine tops

Ø 130 x H 76

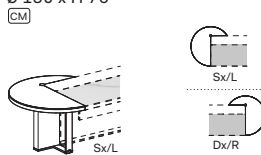

913.PE.02.13_ Dx/R - Sx/L

Tavoli riunione H. 75 cm con piani di lavoro interi in melaminico sp. 5 cm con bordi perimetrali in ABS / Meeting tables H.75 cm with whole worktops in melamine 5 cm thick with perimetrical edges in ABS

P 120 - H 75

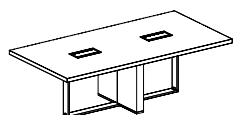

913.TR.41.24_ L 240

Ø 140 - H 75

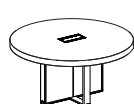

913.TR.11.14_

Libreria con ante a ribalta / Bookshelf with flap doors

P 45 - H 158

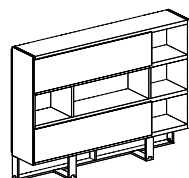

913.CL.RL.20_ L 215

Note:

1 Le finiture in vetro serigrafato non sono in pronta consegna. Per la disponibilità contattare l'ufficio commerciale / Silkscreen glass finishes are not in prompt delivery. Please contact the commercial department to check availability;

2 Le dimensioni sono espresse in cm - consultare il listino prezzi per le caratteristiche tecniche, i codici degli articoli e delle finiture/Dimensions are stated in cm - for technical characteristics, article code numbers and finishing see price list;

3 Per la scelta dei contenitori e degli accessori vari, consultare il relativo listino o catalogo/To choose storage units and accessories, please check correspondent price list or catalogue;

Prodotti non in pronta consegna. Per la disponibilità contattare l'ufficio commerciale/Items not in prompt delivery. Please contact the commercial department to check availability;

Ai tavoli con allungo a giorno è possibile integrare la cassetteria 913.MC.02.06_ / It is possible to integrate 913.MC.02.06_ pedestals in the tables with open extension.

PI Piano intero/Full worktop.

CM Piano composto/Compound worktop.

Cassettiera con 1 cassetto per tavolo con allungo a giorno / Drawer with one drawer for tables with open lateral extension 

L 60 P 50 x H 36,5

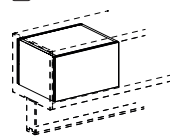

913.MC.02.06_

Accessori per cassetiera cod. 913.MC.02.06 / Accessories for drawer cod. 913.MC.02.06 

L 56 P 41 x H 11

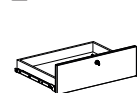

913.CS.01.05

Cassetto Optional interno /
Optional internal drawer

L 55 P 40 x H 8

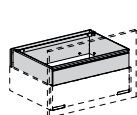

913.CA.S6.08

Reggicartella per cassetto /
Frame for folders for drawers

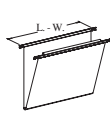

503.CS.P1.00 L 33

503.CS.P2.00 L 39

Note: Per l'integrazione degli accessori con la cassetiera consultare il manuale tecnico / For integration of accessories with the drawers please check technical manual

Cassettiere su ruote / Pedestals on castors

L 42 P 57 x H 55,5



550.CS.10.04_

Melaminico
/Melamine



550.CS.20.04_

Melaminico
/Melamine



L 32,2 P 54,2 x H 55,6



550.CS.1M.03_

Metalliche
/Metallic



550.CS.2M.03_

Metalliche
/Metallic

L 42,2 P 54,2 x H 55,6



550.CS.1M.04_

Metalliche - Vaschetta
porta cancelleria inclusa
/Metallic - Stationery tray
included



550.CS.2M.04_

Metalliche - Vaschetta
porta cancelleria inclusa
/Metallic - Stationery tray
included

Note: Per portacancelleria cassetti, vedi capitolo DV300-Accessori / For stationary tray, see chapter DV300-Accessories.

Accessori per Elettrificazione - Vari / Accessories for Electrification - Various



L 90 P 60 x H 2



300.AP.S1.02 L 20,5
300.AP.S1.03 L 30
300.AP.S1.04 L 42

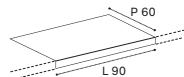

300.AS.01.09

Note:

1 Le finiture in vetro serigrafato non sono in pronta consegna. Per la disponibilità contattare l'ufficio commerciale / Silkscreen glass finishes are not in prompt delivery. Please contact the commercial department to check availability;

2 Le dimensioni sono espresse in cm - consultare il listino prezzi per le caratteristiche tecniche, i codici degli articoli e delle finiture / Dimensions are stated in cm - for technical characteristics, article code numbers and finishing see price list;

3 Per la scelta dei contenitori e degli accessori vari, consultare il relativo listino o catalogo / To choose storage units and accessories, please check correspondent price list or catalogue;

■ Prodotti non in pronta consegna. Per la disponibilità contattare l'ufficio commerciale / Items not in prompt delivery. Please contact the commercial department to check availability;

■ Articoli prodotti solo su richiesta / Items produced only on demand;

■ Con serratura / With lock.

⊗ Ai tavoli con allungo a giorno è possibile integrare la cassetiera 913.MC.02.06_ / It is possible to integrate 913.MC.02.06_ pedestals in the tables with open extension.

Noto

DV911

La collezione riprende l'idea del classico tavolo da lavoro su cavalletto. La struttura è in legno massello e il piano, disponibile nelle versioni rettangolare e rotonda, è proposto in tre diverse finiture che conferiscono ad ogni tavolo un carattere particolare.

The collection of tables recalls the idea of the classic work table on trestle legs. The structure is in solid wood and the top, available in the rectangular and round versions, is available in three different finishes that give each table a particular character.











Il piano in gres
porcellanato per un
ambiente importante e
raffinato.

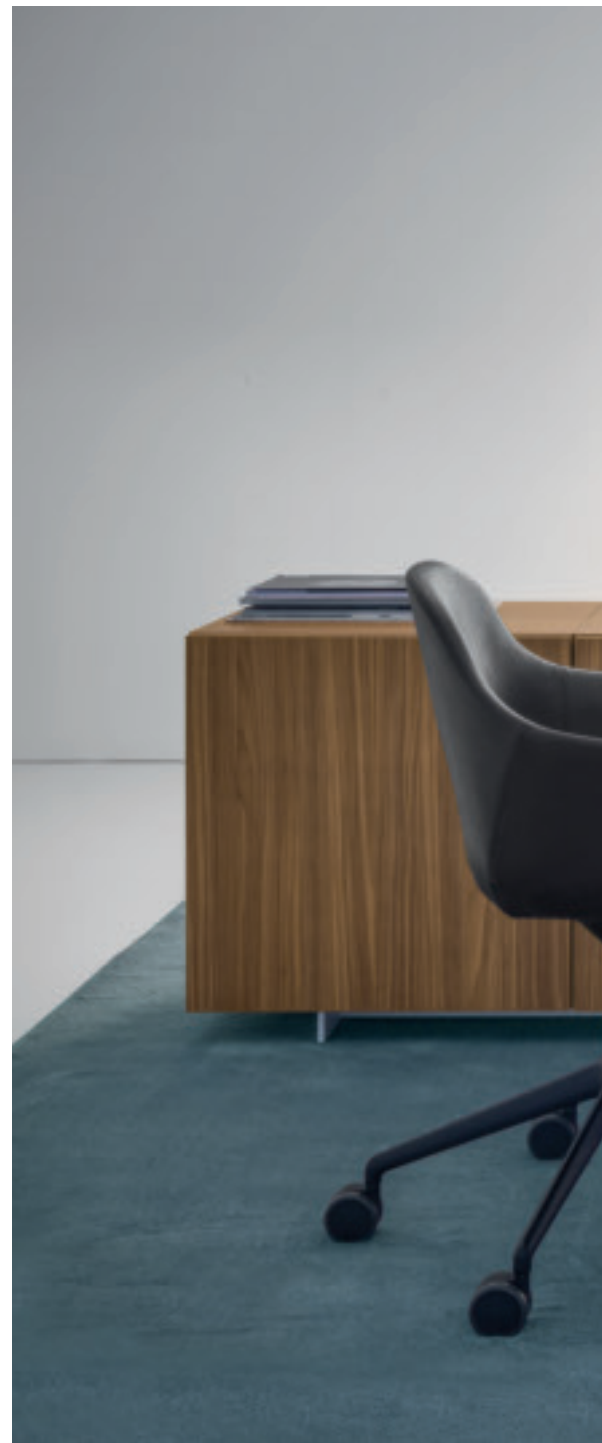

*The porcelain
stoneware top
for an important
and refined
environment.*



Executives













Tavoli / Tables

Piani di lavoro in vetro sp. 1.2 cm, con bordi perimetrali lavorati a filo lucido / Glass worktop 1.2 cm thick, with outer polished edges

Piano di lavoro in vetro temprato trasparente sp. 0.8 cm, accoppiato con piano in gres porcellanato sp. 0.6 cm / Worktop in 0.8 cm thick transparent tempered glass, coupled with a 0.6 cm thick porcelain stoneware worktop



Piani di lavoro sp. 2.7 cm, in cuoio con cuciture / Worktop 2.7 cm thick, in leather with stitches



Gambe in legno / Wooden legs



Travi in legno per piani in vetro / Wooden legs for glass worktops

Travi metalliche per piani ciechi e canalizzazione / Metallic beams for non-transparent worktops and canalization



Modesty panel / Modesty panel

Modesty panel in melaminico sp. 2.5 cm / Melamine modesty panel 2.5 cm thick

Modesty panel sp. 2.7 cm, in cuoio con cuciture / Modesty panel 2.7 cm thick, in leather with stitches

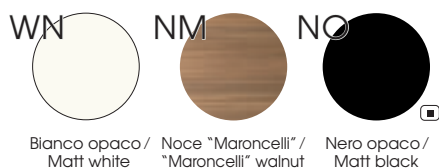

Note

▣ Prodotti non in pronta consegna. Per la disponibilità contattare l'ufficio commerciale / Items not in prompt delivery. Please contact the commercial department to check availability;

Tavoli scrivania con piani in vetro/Desk tables with glass work-top

L 200 P 100 x H 73,5



911.TV.04.20_

L 200 P 60 x H 73,5

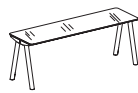

911.TV.01.20_

L 180 P 90 x H 73,5



911.TV.03.18_

Tavoli scrivania con piani in gres porcellanato/Desk tables with porcelain stoneware work-top

L 200 P 100 x H 73,9



911.TV.04.20_

L 200 P 60 x H 73,9



911.TV.01.20_

L 180 P 90 x H 73,9



911.TV.03.18_

Tavoli con piani in cuoio/Desk tables with leather work-top

L 200 P 100 x H 75,2



911.TS.04.20_

L 200 P 60 x H 75,2

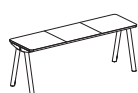

911.TS.44.20_

L 180 P 90 x H 75,2



911.TS.03.18_

Tavoli scrivania/riunione/Meeting-desk tables

L 240 P 120 x H 73,5



911.TV.06.24_

L 178 P 149 x H 73,5



911.TV.28.18_

Ø 140 x H 73,5



911.TV.28.14_

L 240 P 120 x H 73,9



911.TV.06.24_

L 178 P 149 x H 73,9



911.TV.28.18_

Ø 140 x H 73,9



911.TV.28.14_

L 240 - P 120 - H 75,2



911.TR.41.24_

L 178 - P 149 - H 75,2



911.TR.21.18_

Ø 140 - H 75,2



911.TR.21.14_

Note:

1 Le finiture gres e cuoio non sono in pronta consegna. Per la disponibilità contattare l'ufficio commerciale /Porcelain stoneware and leather finishes are not in prompt delivery. Please contact the commercial department to check availability;

2 Per la scelta dei contenitori e degli accessori vari, consultare il relativo listino o catalogo/To choose storage units and accessories, please check correspondent price list or catalogue;

3 Le dimensioni sono espresse in cm - consultare il listino prezzi per le caratteristiche tecniche, i codici degli articoli e delle finiture/Dimensions are stated in cm - for technical characteristics, article code numbers and finishing see price list;

4 Prodotti non in pronta consegna. Per la disponibilità contattare l'ufficio commerciale/Items not in prompt delivery. Please contact the commercial department to check availability;

Con gambe in legno e travi in legno /Wood legs and beams

Con gambe in legno e travi in metallo /Wood legs and metal beams

Gres/Gres

Vetro/Glass

Cuoio/Leather

Tavoli scrivania per integrazione su barra (DV504)/Desk tables for integration on bar (DV504)

<p>L 200 P 100 x H 73,5 V C</p> <p>911.TV.32.20_</p>	<p>L 200 P 60 x H 73,5 V C</p> <p>911.TV.30.20_</p>	<p>L 180 P 90 x H 73,5 V C</p> <p>911.TV.31.18_</p>	<p>L 200 P 100 x H 73,9 G ● ■</p> <p>911.TV.32.20_</p>	<p>L 200 P 60 x H 73,9 G ● ■</p> <p>911.TV.30.20_</p>	<p>L 180 P 90 x H 73,9 G ● ■</p> <p>911.TV.31.18_</p>
<p>L 200 P 100 x H 75,2 C ● ■</p> <p>911.TI.22.20_</p>	<p>L 200 P 60 x H 75,2 C ● ■</p> <p>911.TI.20.20_</p>	<p>L 180 P 90 x H 75,2 C ● ■</p> <p>911.TI.21.18_</p>			

Tavoli per integrazione su moduli base (DV504)/Desks for integration on modules (DV504 series)

<p>L 200 P 100 x H 73,5 V C</p> <p>911.TV.09.20_</p>	<p>L 200 P 60 x H 73,5 V C</p> <p>911.TV.29.20_</p>	<p>L 180 P 90 x H 73,5 V C</p> <p>911.TV.11.18_</p>	<p>L 200 P 100 x H 73,9 G ● ■</p> <p>911.TV.09.20_</p>	<p>L 200 P 60 x H 73,9 G ● ■</p> <p>911.TV.29.20_</p>	<p>L 180 P 90 x H 73,9 G ● ■</p> <p>911.TV.11.18_</p>
<p>L 200 P 100 x H 75,2 C ● ■</p> <p>911.TI.13.20_</p>	<p>L 200 P 60 x H 75,2 C ● ■</p> <p>911.TI.01.20_</p>	<p>L 180 P 90 x H 75,2 C ● ■</p> <p>911.TI.15.18_</p>			

Cassettiere su ruote/Pedestals on castors

<p>L 42 P 57 x H 55,5 ●</p> <p>550.CS.10.04_ Melaminico /Melamine</p>	<p>L 42 P 57 x H 55,5 ●</p> <p>550.CS.20.04_ Melaminico /Melamine</p>	<p>L 32,2 P 54,2 x H 55,6 ● ■</p> <p>550.CS.1M.03_ Metalliche /Metallic</p>	<p>L 32,2 P 54,2 x H 55,6 ● ■</p> <p>550.CS.2M.03_ Metalliche /Metallic</p>	<p>L 42,2 P 54,2 x H 55,6 ●</p> <p>550.CS.1M.04_ Metalliche - Vaschetta porta cancelleria inclusa /Metallic - Stationery tray included</p>	<p>L 42,2 P 54,2 x H 55,6 ●</p> <p>550.CS.2M.04_ Metalliche - Vaschetta porta cancelleria inclusa /Metallic - Stationery tray included</p>
---------------------------------------------------------------------------	---------------------------------------------------------------------------	---------------------------------------------------------------------------------	---------------------------------------------------------------------------------	------------------------------------------------------------------------------------------------------------------------------------------------	------------------------------------------------------------------------------------------------------------------------------------------------

Note: Per portacancelleria cassetti, vedi capitolo DV300-Accessori/For stationery tray, see chapter DV300-Accessories.

Modesty panel

P 1,8 x H 32

911.MP.03.08_ L 76
911.MP.01.18_ L 127
911.MP.01.20_ L 147

Modesty panel in cuoio/Leather modesty panel

P 2 x H 32
C ■

911.MP.03.08_ L 76
911.MP.01.18_ L 127
911.MP.01.20_ L 147

- Note:
- 1 Le finiture gres e cuoio non sono in pronta consegna. Per la disponibilità contattare l'ufficio commerciale /Porcelain stoneware and leather finishes are not in prompt delivery. Please contact the commercial department to check availability;
 - 2 Per la scelta dei contenitori e degli accessori vari, consultare il relativo listino o catalogo/To choose storage units and accessories, please check correspondent price list or catalogue;
 - 3 Le dimensioni sono espresse in cm - consultare il listino prezzi per le caratteristiche tecniche, i codici degli articoli e delle finiture/Dimensions are stated in cm - for technical characteristics, article code numbers and finishing see price list;
 - Con gambe in legno e travi in legno /Wood legs and beams
 - Con gambe in legno e travi in metallo /Wood legs and metal beams
 - Gres/Gres
 - Cuoio/Leather
 - Con serratura/With lock
 - Vetro/Glass

Accessori per canalizzazione – Elettrificazione – Vari/Accessories for wire management – Electrification – Various

300.AC.26.02 L 24,5 300.AC.26.03 L 34,5 300.AC.26.04 L 44,5	300.AC.20.02 L 24,5 300.AC.20.03 L 34,5 300.AC.20.04 L 44,5	300.AC.25.02 L 23,5 300.AC.25.03 L 33,5 300.AC.25.04 L 43,5 Marsupio/Basket	300.AP.S1.02 L 20,5 300.AP.S1.03 L 30 300.AP.S1.04 L 42 Per/For top access 300.AC.26,5	300.AT.A6.02 L 21 300.AT.A6.03 L 25,5 300.AT.A6.04 L 39	300.AP.T4.01 300.AP.T5.01 – UK <input type="checkbox"/> 300.AP.T6.01 – US <input type="checkbox"/>	300.AP.T8.11 300.AP.T8.14 300.AP.T8.17 300.AP.T8.20
L 32 x P 12,3						
300.AC.38.03_H 3	300.AC.67.03 Marsupio per top access 300.AC.38.03 / Basket for top access 300.AC.38.03	300.AP.V1.00	911.AP.08.06 Canalina verticale per gamba /Vertical cable channel for leg	300.AP.F1.00	300.AP.T7.01 Ø 6 300.AP.T8.01 Ø 8	
P 17 - H 9						
911.AP.01.20_L 146 Per tavoli P. 60 cm /For desks P.60	911.AP.41.20_L 180 Carter canaline singole per piani in vetro/Covering carter for glass worktops	911.AP.02.18_L 126 911.AP.02.20_L 146 Per tavoli P. 90-100-120 cm /For desks P. 90-100-120 cm	911.AP.03.07_L 71 Per tavoli tondi /For round tables	911.AP.45.08 L 84 911.AP.43.18 L 160 911.AP.43.20 L 180 Carter canaline doppie per piani in vetro/Carter for double cable channels for glass worktops	911.AP.42.20_L 182 Carter canaline singole per piani in vetro su barra/Carter for single cable channels for glass worktops on bar	911.AP.44.18 L 162 911.AP.44.20 L 182 Carter canaline doppie per piani in vetro su barra/Carter for double cable channels for glass worktops on bar
L 90 P 60 x H 2						
300.AS.01.09_	300.AC.06.05_					

Bracci porta video/Arms for video support

300.AC.02.01 Braccio porta video mobile su piano /Dynamic arm for video support on deskbase	300.AC.02.02 Doppio braccio porta video mobile su piano/2 dynamic arms for video support on deskbase	300.AC.01.01 Braccio porta video statico su palo/Static arm for video support on pole	300.AC.01.02 Doppio braccio porta video statico su palo/2 Static arms for video support on pole

Note:

1 Le finiture gres e cuoio non sono in pronta consegna. Per la disponibilità contattare l'ufficio commerciale /Porcelain stoneware and leather finishes are not in prompt delivery. Please contact the commercial department to check availability;

2 Per la scelta dei contenitori e degli accessori vari, consultare il relativo listino o catalogo/To choose storage units and accessories, please check correspondent price list or catalogue;

3 Le dimensioni sono espresse in cm – consultare il listino prezzi per le caratteristiche tecniche, i codici degli articoli e delle finiture/Dimensions are stated in cm – for technical characteristics, article code numbers and finishing see price list;

4 Prodotti non in pronta consegna. Per la disponibilità contattare l'ufficio commerciale/Items not in prompt delivery. Please contact the commercial department to check availability;

5 Articolli prodotti solo su richiesta/Items produced only on demand;

6 Fino ad esaurimento/Until exhaustion;

7 Cuoio/Leather

Tokio

DV909

Una collezione di tavoli direzionali il cui segno stilistico si distingue per la purezza delle linee e dove ogni singolo dettaglio è studiato per esaltare la struttura architettonica di un tavolo dal forte impatto estetico.

The collection of executive tables is the purity of lines, where every single detail is designed to enhance the architectural structure of a table with a strong aesthetic impact.











Tavoli / Tables

Piani di lavoro sp. 3.7 cm, in folding con laminatino FENIX /
Folding worktops 3.7 cm thick, in FENIX laminate



Piani di lavoro sp. 4.2 cm, in listellare placcato laminato FENIX con bordi in ABS sp. 0.1 cm /
Worktop 4.2 cm thick in FENIX laminate with 0.1 cm ABS edge-profiles



Strutture metalliche / Metal structures

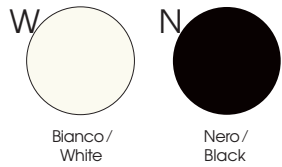

Note

▣ Prodotti non in pronta consegna. Per la disponibilità contattare l'ufficio commerciale / Items not in prompt delivery. Please contact the commercial department to check availability;

Tavoli riunione/Meeting tables

L 140 P 140 x H 75



909.TR.32.14_

L 240 P 120 x H 75

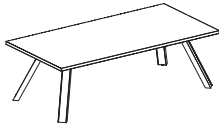

909.TR.22.24_

L 300 P 120 x H 75

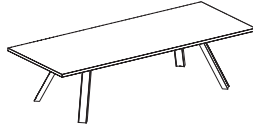

909.TR.22.30_

L 360 P 120 x H 75

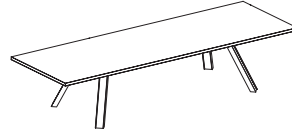

909.TR.22.36_

L 380 P 120 x H 75

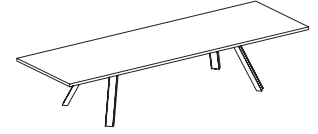

909.TR.22.38_

Accessori per canalizzazione - Elettrificazione / Accessories for wire management - Electrification

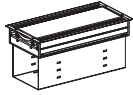

300.AC.26.02 L 24,5
300.AC.26.03 L 34,5
300.AC.26.04 L 44,5



300.AC.20.02_ L 24,5
300.AC.20.03_ L 34,5
300.AC.20.04_ L 44,5

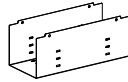

300.AC.25.02 L 23,5
300.AC.25.03 L 33,5
300.AC.25.04 L 43,5
Marsupio/Basket



300.AP.S1.02 L 20,5
300.AP.S1.03 L 30
300.AP.S1.04 L 42
Per/For top access 300.AC.26_



300.AP.V1.00



300.AP.V2.15



909.AP.08.06
Canale passacavi per gamba
/Cable channel for leg



300.AP.15.11 L 110
300.AP.15.14 L 140
300.AP.15.16 L 160

Note:

Per la scelta dei contenitori e degli accessori vari, consultare il relativo listino o catalogo/To choose storage units and accessories, please check correspondent price list or catalogue;

Le dimensioni sono espresse in cm - consultare il listino prezzi per le caratteristiche tecniche, i codici degli articoli e delle finiture/Dimensions are stated in cm - for technical characteristics, article code numbers and finishing see price list;

Prodotti non in pronta consegna. Per la disponibilità contattare l'ufficio commerciale/Items not in prompt delivery. Please contact the commercial department to check availability;

Articoli prodotti solo su richiesta/Items produced only on demand.

Fino ad esaurimento/Until exhaustion;

Rym

DV905

Prestigiosa collezione di scrivanie direzionali per ufficio, dove la ricerca progettuale trova massima espressione. Ampie superfici, stile minimal, ricerca del dettaglio esprimono l'anima di questa collezione.

Prestigious executive collection, where the research of design finds its highest expression. Large surfaces, minimalist style and detail research express the soul of this collection.



Tra i diversi dettagli presenti nella collezione emerge in modo caratterizzante l'unione ad angolo delle gambe con i profili del piano di lavoro.



Among the different details present in the collection emerges in a way characterizing the corner union of the legs with the profiles of the worktop.

























Tavoli / Tables

Piani di lavoro sp. 5 cm, in laminatino /
Worktops 5 cm thick, in low pressure laminate



Piani di lavoro sp. 5 cm, in laminatino Fenix /
Worktops 5 cm thick, in low pressure Fenix laminate



Piani di lavoro sp. 5 cm, in cuoio con cuciture /
Worktop 5 cm thick, in leather with stitches



Piani di lavoro sp. 0.5 cm, in vetro retrolaccato /
Worktops 0.5 cm thick, rear-lacquered glass



Piani di lavoro sp. 0.5 cm, in vetro temprato retrolaccato acidato con bordi perimetrali lavorati a filo lucido /
Worktops 0.5 cm thick, rear-lacquered and acetated tempered glass with outer polished edges



Strutture metalliche / Metal structures

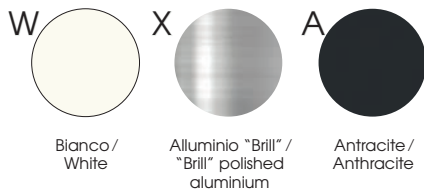

Mobili di servizio / Service units

Scocca, ripiani sp. 2.5 cm e ante sp. 1.8 cm, in melaminico (*) o laminato (**)
Body, shelves 2.5 cm and doors 1.8 cm thick, in melamine (*) or laminate (**)



Note

☐ Prodotti non in pronta consegna. Per la disponibilità contattare l'ufficio commerciale / Items not in prompt delivery. Please contact the commercial department to check availability

Tavoli scrivania/Desks

L 180 P 90 x H 75

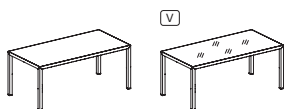

905.TS.03.18_

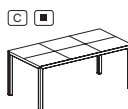

905.TV.03.18_

P 100 x H 75

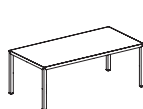

905.TS.04.20_L 200
905.TS.04.22_L 220

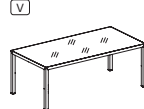

905.TV.04.20_L 200
905.TV.04.22_L 220

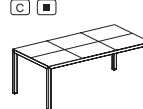

905.TS.04.22_L 220

Tavoli e allunghi dattilo / Typing and extension tables

L120 P 60 x H 75

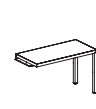

905.TD.01.12_
Sx/L - Dx/R

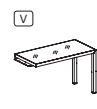

905.DV.01.12_
Sx/L - Dx/R



905.TD.01.12_
Sx/L - Dx/R

Tavoli per integrazione con mobili di servizio / Desk for integration with service units

P 100 x H 75

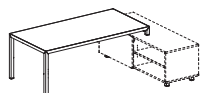

905.TI.14.20_L 200
905.TI.14.22_L 220

P 100 x H 75

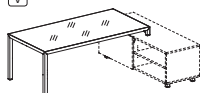

905.TV.10.20_L 200
905.TV.10.22_L 220

P 100 x H 75

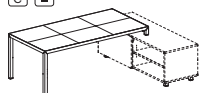

905.TI.14.20_L 200
905.TI.14.22_L 220

Mobili di servizio e cassetiera interna / Service units and internal pedestal

L 180 P 66 x H 61

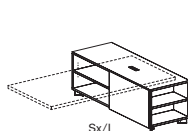

905.MS.6_18_
Sx/L - Dx/R
Indipendenti e per integrazione / Independent and for integration

L 180 P 92,5 x H 61

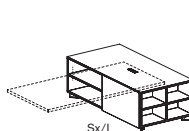

905.MS.9_18_
Sx/L - Dx/R
Indipendenti e per integrazione / Independent and for integration

L 42 P 55 x H 48

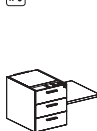

550.CM.01.04_

Modesty panels

P 1,8 x H 38



905.MP.01.10_L 100 Dattilo/Typing L 120
905.MP.01.13_L 130 Tavoli+MS/Desks+SU L 200
905.MP.01.14_L 140 Tavoli+MS/Desks+SU L 160-200-220
905.MP.01.16_L 160 Tavoli+MS/Desks+SU L 180-220
905.MP.01.18_L 180 Tavoli/Desks L 200-220

Modesty Panel in cuoio / Leather Modesty Panel

P 1,8 x H 38

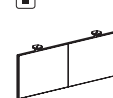

905.MP.01.10_L 100 Dattilo/Typing
905.MP.01.13_L 130
905.MP.01.14_L 140
905.MP.01.16_L 160
905.MP.01.18_L 180

Note: La finitura nero opaco non è in pronta consegna, per la disponibilità contattare l'ufficio commerciale. / Matt black finishes is not in prompt delivery. Please contact the commercial department to check availability.

Tavoli scrivania L 200 x P 100 con mobile di servizio L 180 x P 66/Desks W 200 x D 100 with service unit W 180 x D 66

L 239 P 180 x H 75

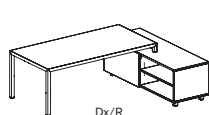

905.TM.6_20
Sx/L - Dx/R

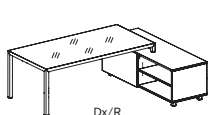

905.TV.6_20
Sx/L - Dx/R

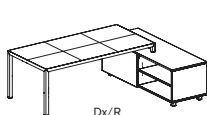

905.TM.6_20
Sx/L - Dx/R

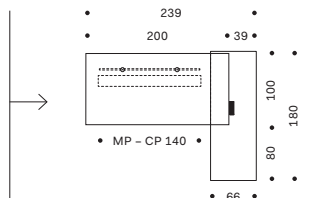

Tavoli scrivania L 220 x P 100 con mobile di servizio L 180 x P 66/Desks W 220 x D 100 with service unit W 180 x D 66

L 259 P 180 x H 75

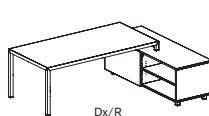

905.TM.6_22
Sx/L - Dx/R

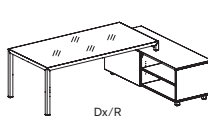

905.TV.6_22
Sx/L - Dx/R

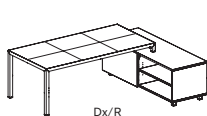

905.TM.6_22
Sx/L - Dx/R

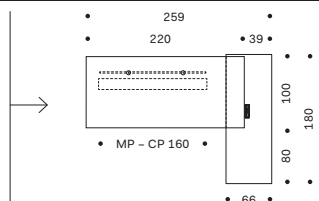

Tavoli scrivania L 200 x P 100 con mobile di servizio L 180 x P 92,5/Desks W 200 x D 100 with service unit W 180 x D 92,5

L 251 P 180 x H 75

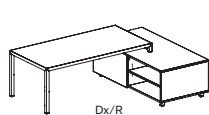

905.TM.9_20
Sx/L - Dx/R

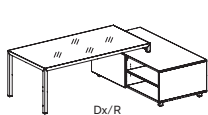

905.TV.9_20
Sx/L - Dx/R

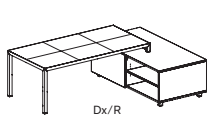

905.TM.9_20
Sx/L - Dx/R

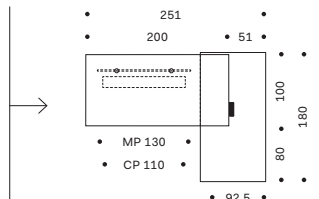

Note:

1 La finitura nero opaco e le finiture in cuoio non sono in pronta consegna. Per la disponibilità contattare l'ufficio commerciale; / Matt black finish and leather finishes are not in prompt delivery. Please contact the commercial department to check availability;

2 Per la scelta dei contenitori e degli accessori vari, consultare il relativo listino o catalogo; / To choose storage units and accessories, please check correspondent price list or catalogue;

3 I tavoli possono essere montati sui mobili di servizio P 66 e P 92,5 cm (destri o sinistri). Per ogni soluzione compositiva è disponibile a listino la dimensione del corrispondente modesty panel (vedi relativa quota indicata con MP) e del corrispondente canale passacavi (vedi relativa quota indicata con CP). / The desks can be fixed on the service units depth 66 and depth 92.5 cm (right or left hand). To order the modesty panel please check the dimensions marked with MP and the dimensions marked with CP for the relevant cables channel;

Tavoli scrivania L 220 x P 100 con mobile di servizio L 180 x P 92,5/Desks W 220 x D 100 with service unit W 180 x D 92,5

L 271 P 180 x H 75

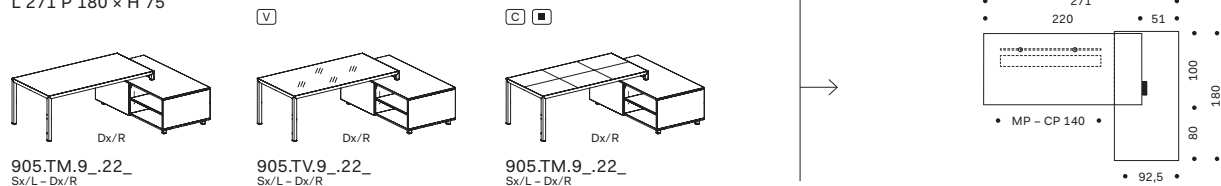

Tavoli scrivania L 160 x P 160 con mobile di servizio L 180 x P 66/Desks W 160 x D 160 with service unit W 180 x D 66

L 199 P 255 x H 75

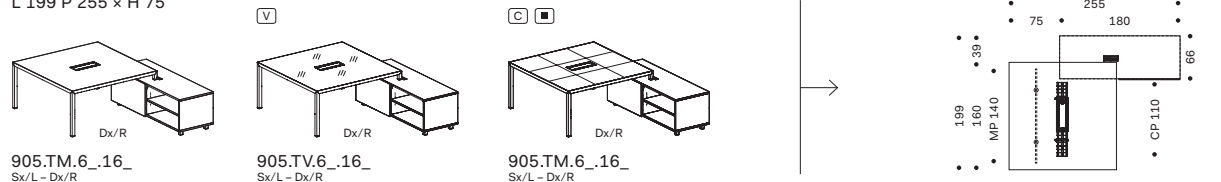

Tavoli scrivania L 160 x P 160 con mobile di servizio L 180 x P 92,5 / Desks W 160 x D 160 with service unit W 180 x D 92,5

L 213 P 255 x H 75

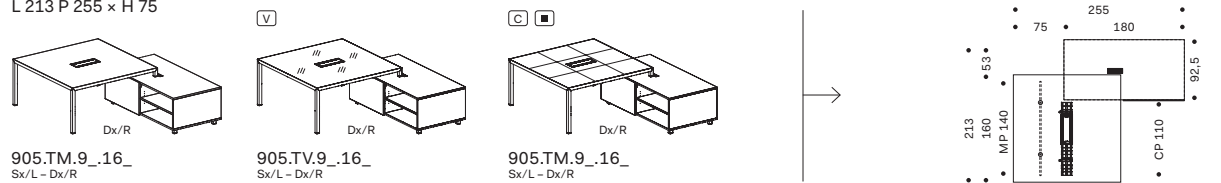

Tavoli riunione/Meeting tables

L 160 P 160 x H 75



L 240 P 120 x H 75



P 120 x H 75



L 300 P 120 x H 75

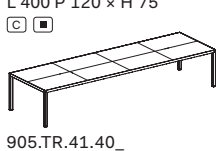

Cassettiere su ruote/Pedestals on castors

L 42 P 57 x H 55,5

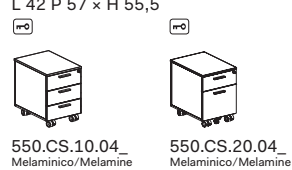

L 32,2 P 54,2 x H 55,6

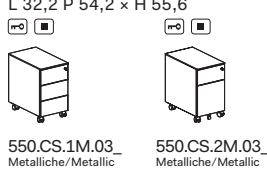

L 42,2 P 54,2 x H 55,6

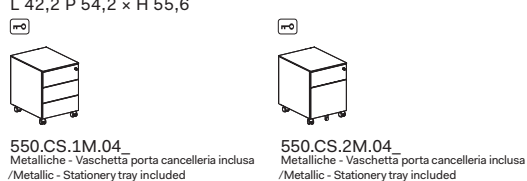

Note: Per portacancelleria cassetti, vedi capitolo DV300-Accessori/For stationery tray, see chapter DV300-Accessories.

Accessori per canalizzazione - Elektrificazione - Vari/Accessories for wire management - Electrification - Various

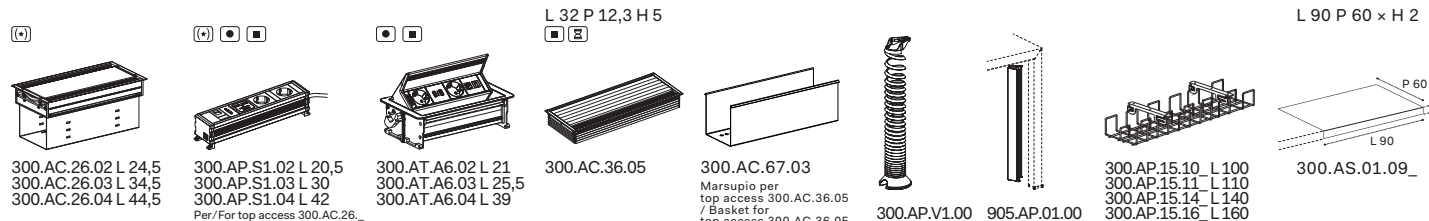

Note:

4 Le dimensioni sono espresse in cm - consultare il listino prezzi per le caratteristiche tecniche, i codici degli articoli e delle finiture/Dimensions are stated in cm - for technical characteristics, article code numbers and finishing see price list;

Articoli prodotti solo su richiesta/Items produced; only on demand;
Prodotti non in pronta consegna. Per la disponibilità contattare l'ufficio commerciale/Items not in prompt delivery. Please contact the commercial department to check availability;

Fino ad esaurimento/Until exhaustion.
Con serratura/With lock; Vetro/Glass;
Cuoio/Leather.

Rodi

DV908

Geometrie in equilibrio. Tavoli con gambe e piani in metallo verniciato, sono disponibili in cinque diverse finiture e si adattano ai molteplici ambienti di lavoro.

Balanced geometries. Desks, with legs and worktops in painted metal, are available in five different finishes and are adaptable to multiple work environments.







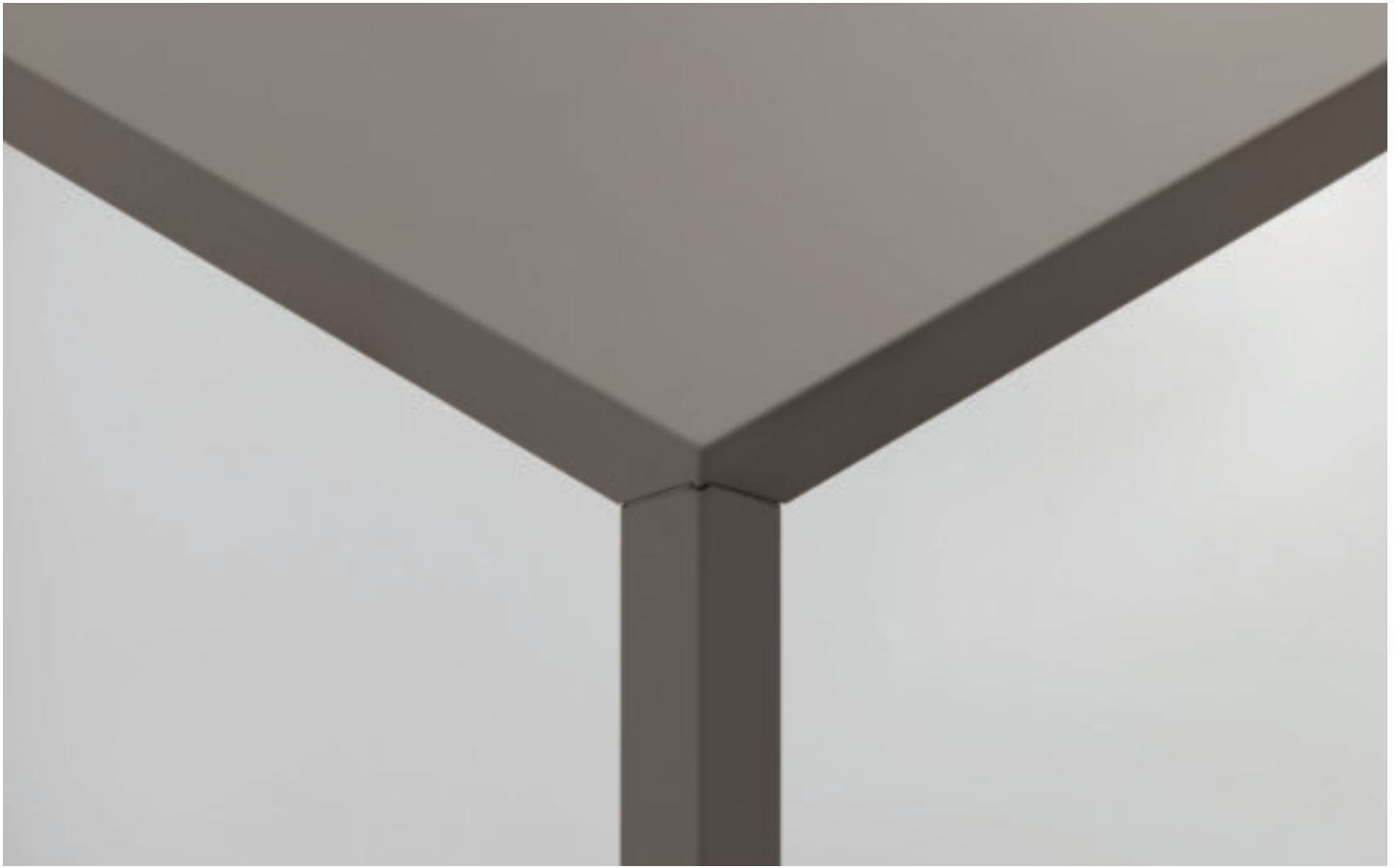

Tavoli / Tables

Piani di lavoro in metallo verniciato, sp. 4 cm / Metal painted worktops, 4 cm thick



Strutture metalliche / Metal structures



Note

❑ Prodotti non in pronta consegna. Per la disponibilità contattare l'ufficio commerciale / Items not in prompt delivery. Please contact the commercial department to check availability.

Dati tecnici / Technical data

Tavoli riunione / Meeting tables

L 200 P 100 x H 75

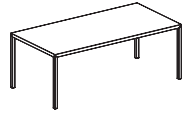

908.TR.42.20_

L 240 P 120 x H 75

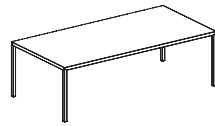

908.TR.41.24_

Accessori per canalizzazione - Elettrificazione / Accessories for wire management - Electrification



300.AP.15.11 L 110
300.AP.15.14 L 140
300.AP.15.16 L 160

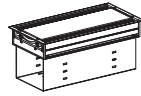

300.AC.26.02 L 24,5
300.AC.26.03 L 34,5
300.AC.26.04 L 44,5



300.AC.20.02_ L 24,5
300.AC.20.03_ L 34,5
300.AC.20.04_ L 44,5

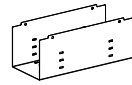

300.AC.25.02 L 23,5
300.AC.25.03 L 33,5
300.AC.25.04 L 43,5
Marsupio / Basket



300.AP.S1.02 L 20,5
300.AP.S1.03 L 30
300.AP.S1.04 L 42
Per / For top access 300.AC.26_



300.AP.V1.00

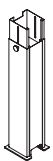

300.AP.V2.15

Note:

① Per la scelta dei contenitori e degli accessori vari, consultare il relativo listino o catalogo / To choose storage units and accessories, please check correspondent price list or catalogue;

② Le dimensioni sono espresse in cm - consultare il listino prezzi per le caratteristiche tecniche, i codici degli articoli e delle finiture / Dimensions are stated in cm - for technical characteristics, article code numbers and finishing see price list;

❑ Prodotti non in pronta consegna. Per la disponibilità contattare l'ufficio commerciale / Items not in prompt delivery. Please contact the commercial department to check availability;

❑ Articoli prodotti solo su richiesta / Items produced only on demand.

Tay

DV903

Una collezione di scrivanie per ufficio direzionali di grande impatto estetico, dove la ricchezza dei piani di lavoro e la preziosità delle finiture generano una perfetta sintesi tra funzione e design, tra eleganza e tecnologia.

A collection of great aesthetic impact, where the luxury of the worktops and the preciousness of the finishes create perfect balance between functionality and design, between elegance and technology.







La serie si arricchisce
di tavoli in
"gres porcellanato"
nelle versioni bianco
"extra-white" e nero
"marquinia".



*The series enriches its
finish options with the
"porcelain stoneware"
tables, in the
"extra-white" and
black "marquinia"
versions.*







Executives











Tavoli / Tables

Piani di lavoro sp. 1 cm, in vetro temprato retrolaccato con bordi perimetrali lavorati a filo lucido / Worktops 1 cm thick, rear-lacquered tempered glass with outer polished edges

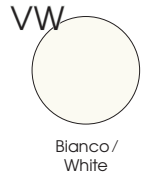

Piani di lavoro sp. 1 cm, in vetro temprato retrolaccato acidato con bordi perimetrali lavorati a filo lucido / Worktops 1 cm thick, rear-lacquered and acetated tempered glass with outer polished edges

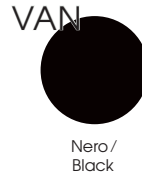

Piani di lavoro sp. 1.2 cm, in vetro fumé temprato con bordi perimetrali lavorati a filo lucido / Worktops 1.2 cm thick, smoked grey tempered glass with outer polished edges



Piano di lavoro in vetro temprato trasparente sp. 0.8 cm, accoppiato con piano in gres porcellanato sp. 0.6 cm / Worktop in 0.8 cm thick transparent tempered glass, coupled with a 0.6 cm thick porcelain stoneware worktop



Gambe metalliche / Metal legs

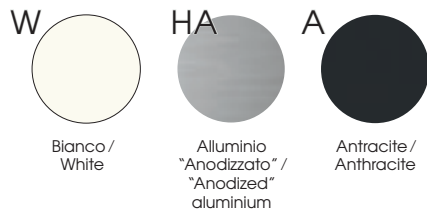

Mobili di servizio / Service units

Scocca, ripiani sp. 2.5 cm e ante sp. 1.8 cm, in melaminico (*) o laminato (**)
Body, shelves 2.5 cm and doors 1.8 cm thick, in melamine (*) or laminate (**)

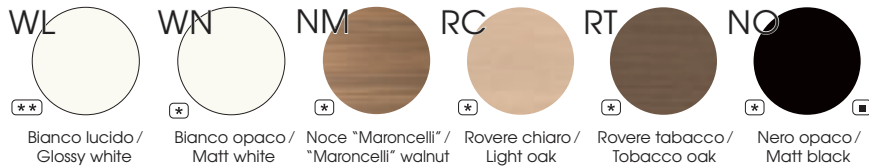

Note

☐ Prodotti non in pronta consegna. Per la disponibilità contattare l'ufficio commerciale / Items not in prompt delivery. Please contact the commercial department to check availability

Tavoli scrivania in vetro/Glass tables

P 100 x H 75 V	P 60 x H 75 V	V
903.TV.07.20_L 200	903.TV.05.10_L 100	903.TV.04.10_L 100

Tavoli scrivania in gres/Gres tables

P 100 x H 75 G	P 60 x H 75 G	G
903.TV.07.20_L 200	903.TV.05.10_L 100	903.TV.04.10_L 100

Tavoli per integrazione con mobili di servizio /Desk for integration with service units

P 100 x H 75 V	P 100 x H 75 G
903.TV.09.20_L 200	903.TV.09.20_L 200

Tavoli riunione in vetro/Glass meeting tables

Ø 100 x H 75 V HA	Ø 100 x H 75 V H	P 160 x H 75 V ∞	P 120 x H 75 V ∞
903.TV.14.10_	903.TV.15.10_	903.TV.38.16_L 160	903.TV.56.24_L 240

Tavoli riunione in gres/Gres meeting tables

Ø 100 x H 75 G HA	Ø 100 x H 75 G H	P 140 x H 75 G	P 120 x H 75 G
903.TV.14.10_	903.TV.15.10_	903.TV.38.14_L 140	903.TV.56.24_L 240

Mobili di servizio e cassettera interna /Service units and internal pedestal

L 180 P 66 x H 61 Sx/L	L 180 P 92,5 x H 61 Sx/L	L 42 P 55 x H 48 R	
903.MS.6_18_	903.MS.9_18_	550.CM.01.04_	
Sx/L - Dx/R Indipendenti e per integrazione /Independent and for integration			

Note: La finitura nero opaco non è in pronta consegna, per la disponibilità contattare l'ufficio commerciale. /Matt black finishes is not in prompt delivery. Please contact the commercial department to check availability.

Tavoli scrivania in vetro L 200 con mobile di servizio P 66 (Dx o Sx)/Glass desks L 200 with service unit D 66 (R or L)

L = L 11 - L 12 - L 13 P 180 x H 75

V	G	
903.TV.6_20_	903.TV.6_20_	
Sx/L - Dx/R	Sx/L - Dx/R	

• L 11 = 200 •	• L 12 = 232 •	• L 13 = 241,5 •
• 32 •	• 32 •	• 41,5 •
• MP 120 •	• MP 140 •	• MP 160 •
• CP 160 •	• CP 160 •	• CP 160 •
• 66 •	• 66 •	• 66 •

Tavoli scrivania in vetro L 200 con mobile di servizio P 92,5 (Dx o Sx)/Glass desks L 200 with service unit D 92,5 (R or L)

L = L 14 - L 15 - L 16 P 180 x H 75

V	G	
903.TV.9_20_	903.TV.9_20_	
Sx/L - Dx/R	Sx/L - Dx/R	

• L 14 = 226 •	• L 15 = 245 •	• L 16 = 267,5 •
• 26 •	• 45 •	• 67,5 •
• MP 120 •	• MP 140 •	• MP 160 •
• CP 160 •	• CP 160 •	• CP 160 •
• 92,5 •	• 92,5 •	• 92,5 •

Tavoli scrivania - riunioni in vetro L 160x160 con mobile di servizio P 66 - 92,5 (Dx o Sx) /Glass desks - meeting tables L 160x160 with service unit D 66 - 92,5 (R or L)

L = L 17 P 250 x H 75

V ∞	
903.TV.6_20_	
Sx/L - Dx/R	

L = L 18 P 250 x H 75

V ∞	
903.TV.9_20_	
Sx/L - Dx/R	

Canalizzazione in tondino d'acciaio e modesty panels per tavoli in vetro
/Wire management with steel rod channels and modesty panels for tables with glass tops

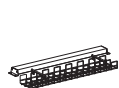

903.AP.15.10_ L 78
Tavoli/Desks L 100
903.AP.15.16_ L 140
Tavoli/Desks L 160
903.AP.15.20_ L 160
Tavoli/Desks 200
903.AP.15.24_ L 160
Tavoli/Desks 240

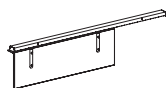

903.MP.04.12_ L 120
Tavoli + MS/Desks + SU L 200
903.MP.04.14_ L 140
Tavoli + MS/Desks + SU L 200
903.MP.04.16_ L 160
Tavoli + MS/Desks + SU L 200
903.MP.04.10_ L 100
Tavoli + MS/Desks + SU L 160
903.MP.05.16_ L 140
Tavoli/Desks L 160
903.MP.05.20_ L 180
Tavoli/Desks L 200

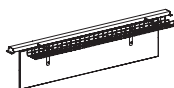

903.MP.07.20_ L 180
Tavoli/Desks L 200
903.MP.07.16_ L 140
Tavoli/Desks L 160
903.MP.07.12_ L 120
Tavoli + MS/Desks + SU L 200
903.MP.07.14_ L 140
Tavoli + MS/Desks + SU L 200
903.MP.07.18_ L 160
Tavoli + MS/Desks + SU L 200
903.MP.07.10_ L 100
Tavoli + MS/Desks + SU L 160

Cassettiere/Pedestals

L 42 P 57 x H 55,5



550.CS.10.04_ Melaminico/Melamine
550.CS.20.04_ Melaminico/Melamine

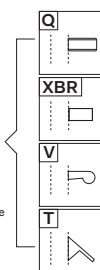

L 32,2 P 54,2 x H 55,6



550.CS.1M.03_ Metalliche/Metallic



550.CS.2M.03_ Metalliche/Metallic

L 42,2 P 54,2 x H 55,6



550.CS.1M.04_ Metalliche/Metallic
Vaschetta porta cancelleria inclusa /Stationery tray included



550.CS.2M.04_ Metalliche/Metallic

Note: Per portacancelleria cassetti, vedi capitolo DV300-Accessori/For stationary tray, see chapter DV300-Accessories.

Accessori per canalizzazione - Elettrificazione - Vari/Accessories for wire management - Electrification - Various

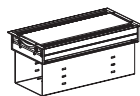

300.AC.26.02 L 24,5
300.AC.26.03 L 34,5
300.AC.26.04 L 44,5



300.AC.20.02_ L 24,5
300.AC.20.03_ L 34,5
300.AC.20.04_ L 44,5

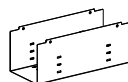

300.AC.25.02 L 23,5
300.AC.25.03 L 33,5
300.AC.25.04 L 43,5
Marsupio/Basket



300.AP.S1.02 L 20,5
300.AP.S1.03 L 30
300.AP.S1.04 L 42
Per/For top access 300.AC.26_



300.AT.A6.02 L 21
300.AT.A6.03 L 25,5
300.AT.A6.04 L 39



300.APT.2.01 Ø 8



300.APT.7.01 Ø 6
300.APT.8.01 Ø 8



300.AP.V1.00

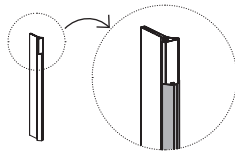

903.AP.08.00

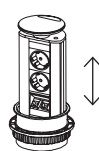

300.AP.T4.01
300.AP.T5.01 - UK
300.AP.T6.01 - US



300.AP.F1.00

L 90 P 60 x H 2

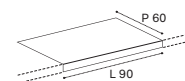

300.AS.01.09_

Note:

- 1 Le finiture in gres non sono in pronta consegna. Per la disponibilità contattare l'ufficio commerciale /Gres finishes are not in prompt delivery. Please contact the commercial department to check availability;
- 2 Per la scelta dei contenitori e degli accessori vari, consultare il relativo listino o catalogo/To choose storage units and accessories, please check correspondent price list or catalogue;
- 3 Le dimensioni sono espresse in cm - consultare il listino prezzi per le caratteristiche tecniche, i codici degli articoli e delle finiture/Dimensions are stated in cm - for technical characteristics, article code numbers and finishing see price list;
- 4 I tavoli possono essere montati sui mobili di servizio P 66 e P 92,5 cm (destri o sinistri) scegliendo tra diverse posizioni. Per ogni soluzione compositiva è disponibile a listino la dimensione del corrispondente modesty panel (vedi relativa

quota indicata con MP) e del corrispondente canale passacavi (vedi relativa quota indicata con CP)/The desks can be mounted on service units depth 66 and 92,5 cm (right or left hand) in different positions. You can find the proper modesty panel to match according to the composition chosen (see sizes indicated with the MP), while the cable channel is indicated with CP;

Articoli prodotti solo su richiesta/Items produced only on demand;

Gambone in alluminio anodizzato / Metal column made in "Anodized" aluminium;

Gambone verniciato a polveri in bianco, alluminio o antracite / Metal column electrostatic painted in white, aluminum or anthracite;

Prodotti non in pronta consegna. Per la disponibilità contattare l'ufficio commerciale/Items not in prompt delivery. Please contact the commercial department to check availability;

Fino ad esaurimento/Until exhaustion;

Con serratura/With lock;

Per eventuali giacenze a magazzino delle precedenti versioni senza top-access, contattare l'ufficio commerciale/To check stock availabilities of table tops without top-access, please contact our commercial department;

Vetro/Glass; G Gres/Gres.

Vertigo

DV901

Eleganza nel design e ricercatezza nei dettagli, sono i tratti distintivi di questa collezione di scrivanie e tavoli riunione, pensata per creare ambienti dove stile e professionalità siano in sintonia con immagine e prestazioni.

Elegant design and refined details are the distinctive features of this collection, conceived to create environments where style and professionalism are in harmony with image and performance.











Executives













Bellezza architettonica
esaltata attraverso
elementi di arredo,
caratterizzati da un
design inconfondibile.
Ogni oggetto al
posto giusto denota
l'ampia flessibilità
della collezione.

*Architectonic beauty
exalted through
furnishing items,
characterised by
distinctive design.
Each element at the
right place to underline
the wide flexibility of
this collection.*













Tavoli / Tables

Piani di lavoro sp. 1.8 cm, in melaminico (*) o laminato (***) con bordi in ABS sp. 0.2 cm /
Worktops 1.8 cm thick, in melamine (*) or laminate (***) with ABS edge-profiles 0.2 cm thick



Piani di lavoro sp. 2 cm, in cuoio con cuciture /
Worktop 2 cm thick, in leather with stitches



Piani di lavoro sp. 1 cm, in vetro temprato retrolaccato con bordi perimetrali lavorati a filo lucido /
Worktops 1 cm thick, rear-lacquered tempered glass with outer polished edges



Piani di lavoro sp. 1 cm, in vetro temprato retrolaccato acidato con bordi perimetrali lavorati a filo lucido /
Worktops 1 cm thick, rear-lacquered and acetated tempered glass with outer polished edges



Piano di lavoro in vetro temprato trasparente sp. 0.8 cm, accoppiato con piano in gres porcellanato sp. 0.6 cm /
Worktop in 0.8 cm thick transparent tempered glass, coupled with a 0.6 cm thick porcelain stoneware worktop



Strutture metalliche / Metal structures

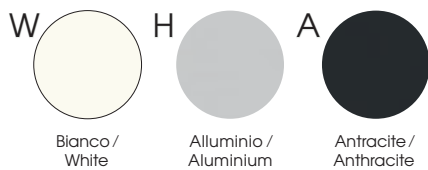

Gambone in metallo con base / Metal column base



Mobili di servizio / Service units

Scocca, ripiani sp. 2.5 cm e ante sp. 1.8 cm, in melaminico (*) o laminato (***) /
Body, shelves 2.5 cm and doors 1.8 cm thick, in melamine (*) or laminate (***)



Note

Prodotti non in pronta consegna. Per la disponibilità contattare l'ufficio commerciale / Items not in prompt delivery. Please contact the commercial department to check availability

Moduli bancone dritti - Moduli bancone curvi 60° - Moduli bancone raccordo 90°/Straight counter units - 60° curved counter units - 90° counter corner units

P 90 x H 75		P 90 x H 74,5 V		P 90 x H 75 G ■	
901.TS.48.18_L 180 901.TS.48.20_L 200	901.TS.03.18_L 180 901.TS.03.20_L 200	901.TV.17.18_L 180 901.TV.17.20_L 200	901.TV.01.18_L 180 901.TV.01.20_L 200	901.TS.48.18_L 180 901.TS.48.20_L 200	901.TS.03.18_L 180 901.TS.03.20_L 200
P 90 x H 74,5 G ■		L 160 P 80 x H 75		L 160 P 80 x H 74,5 V	
901.TV.17.18_L 180 901.TV.17.20_L 200	901.TV.01.18_L 180 901.TV.01.20_L 200	901.TS.02.16_	901.TV.15.16_	901.TS.02.16_	

Tavoli dattilo/Typing tables

L 120 P 60 x H 75		L 120 P 60 x H 74,5 V		L 120 P 60 x H 75 C ■		L 120 P 60 x H 75 G ■	
901.TS.50.12_	901.TS.44.12_	901.TV.19.12_	901.TV.16.12_	901.TS.50.12_	901.TS.44.12_	901.TV.19.12_	901.TV.16.12_

Tavoli riunione/Meeting tables

Ø 100 x H 74,5 V ■ HA		Ø 100 x H 75 G ■ HA		L 100 P 100 x H 75 C ■		L 160 P 160 x H 75 C ■		L 160 P 160 x H 74,5 V ∞	
901.TV.14.10_	901.TV.15.10_	901.TV.14.10_	901.TV.15.10_	901.TR.42.10_	901.TR.42.10_	901.TR.43.16_	901.TV.38.16_		
L 160 P 160 x H 75 C ■		L 240 P 120 x H 75 C ■ ■ ■		L 240 P 120 x H 74,5 V ∞		L 240 P 120 x H 75 C ■		L 240 P 120 x H 75,5 G ■	
901.TR.43.16_	901.TR.51.16_	901.TR.51.16_	901.TR.41.24_	901.TV.36.24_	901.TR.41.24_	901.TV.36.24_			

Allunghi per tavoli scrivania L 160 - 180/Extension tables for desks L 160 - 180

L 120 P 60 x H 75		L 120 P 60 x H 74,5 V		L 120 P 60 x H 75 G ■		L 120 P 60 x H 75 C ■	
901.TD.31.12_Dx/R 901.TD.33.12_Sx/L	901.TD.30.12_Dx/R 901.TD.32.12_Sx/L	901.TV.22.12_Dx/R 901.TV.24.12_Sx/L	901.TV.21.12_Dx/R 901.TV.23.12_Sx/L	901.TV.22.12_Dx/R 901.TV.24.12_Sx/L	901.TV.21.12_Dx/R 901.TV.23.12_Sx/L	901.TD.31.12_Dx/R 901.TD.33.12_Sx/L	901.TD.30.12_Dx/R 901.TD.32.12_Sx/L

Allunghi per tavoli scrivania L 200/Extension tables for desks L 200

L 120 P 60 x H 75 ★		L 120 P 60 x H 74,5 V ★		L 120 P 60 x H 75 G ■ ★		L 120 P 60 x H 75 C ■ ★	
901.TD.27.12_	901.TD.26.12_	901.TV.20.12_	901.TV.04.12_	901.TV.20.12_	901.TV.04.12_	901.TD.27.12_	901.TD.26.12_

Tavoli riunione componibili con gambe centrali rientrate/Modular meeting tables with central recessed legs

L 320 P 80 x H 75 		P 90 x H 75 	 901.TR.55.40_ L 400	 901.TR.55.40_ L 400	L 320 P 160 x H 75
L 320 P 160 x H 75 					L 480 P 160 x H 75
L 480 P 160 x H 75 					

Elementi per tavoli riunione componibili con gambe centrali rientrate/Modular elements for compound meeting tables with central recessed legs

L 160 P 80 x H 75 		P 90 x H 75 901.TR.55.20_ L 200	 901.TR.55.20_ L 200	L 160 P 160 x H 75 				L 160 P 160 x H 74,5 	
-----------------------	--	----------------------------------------	-------------------------	------------------------	--	--	--	--------------------------	--

Tavoli per integrazione con mobili di servizio/Desks for integration with service units

P 90 x H 75 901.TI.15.20_ L 200	P 90 x H 74,5 	P 90 x H 75 	P 90 x H 75 	L 160 P 160 x H 75 901.TI.17.16_ Sx/L	L 160 P 160 x H 74,5 	 901.TV.23.16_ Sx/L
L 160 P 160 x H 75 	L 160 P 160 x H 75 	L 160 P 160 x H 75 	 901.TI.17.16_ Sx/L	 901.TI.19.16_ Sx/L	 901.TI.19.16_ Sx/L	

Note:

- [1] Le finiture gres e cuoio non sono in pronta consegna. Per la disponibilità contattare l'ufficio commerciale/ Porcelain stoneware and leather finishes are not in prompt delivery. Please contact the commercial department to check availability;
- [2] Le dimensioni sono espresse in cm - consultare il listino prezzi per le caratteristiche tecniche, i codici degli articoli e delle finiture/Dimensions are stated in cm - for technical characteristics, article code numbers and finishing see price list;
- [M] Prodotti non in pronta consegna. Per la disponibilità contattare l'ufficio commerciale/Items not in prompt delivery. Please contact the commercial department to check availability;
- [G] Fino ad esaurimento/Until exhaustion;
- [infinity] Per eventuali giacenze a magazzino delle precedenti versioni senza top-access, contattare l'ufficio commerciale /To check stock availabilities of table tops without top-access, please contact our commercial department;
- [HA] Gambone in alluminio anodizzato / Metal column made in "Anodized" aluminium;
- [H] Gambone verniciato a polveri in bianco, alluminio o antracite / Metal column electrostatic painted in white, aluminum or anthracite;
- [V] Vetro/Glass; [C] Cuoio/Leather; [G] Gres/Gres;
- [*] Allunghi montabili anche in posizione centrale sui tavoli scrivania L 160 - 180 - 200 (vedere listino)/Extensions suitable also for central position on desks L 160 - 180 - 200 (see price list);
- [O] Tavoli scrivania con piani composti /Desks with compound worktops.

Esempi posizionamento tavoli riunione P 90 con mobili di servizio/Examples of meeting tables D 90 positioning with service units

L 180 x H 75

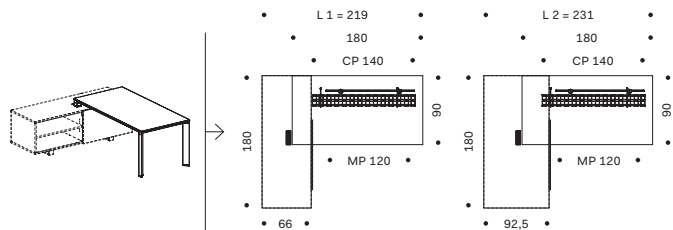

L 200 x H 75

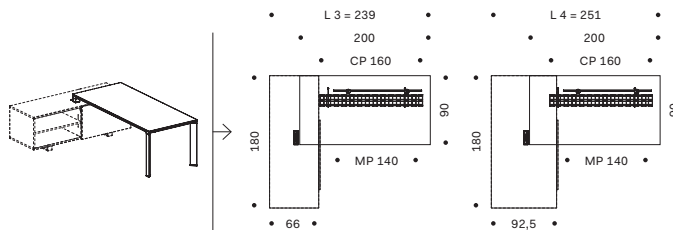

Esempi posizionamento tavoli riunione L 160 con mobili di servizio/Examples of meeting tables W 160 positioning with service units

P 160 x H 75

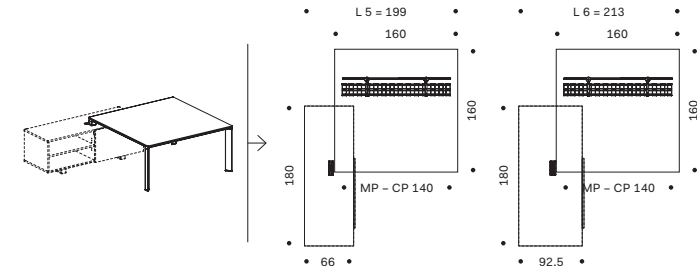

P 160 x H 75

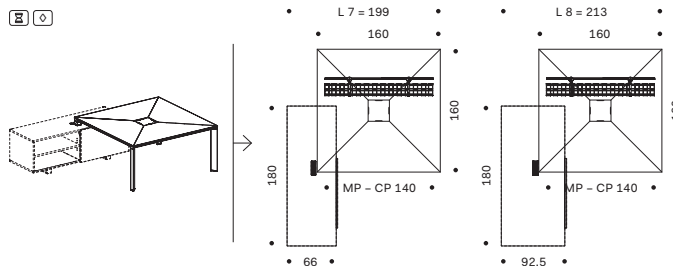

Mobili di servizio e cassetiera interna/Service units and internal pedestals

L 180 P 66 x H 63

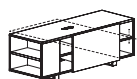

901.MS.6.18_Dx/R - Sx/L
Indipendenti e per integrazione
/Independent and for integration

L 180 P 92,5 x H 63

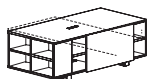

901.MS.9.18_Dx/R - Sx/L
Indipendenti e per integrazione
/Independent and for integration

L 42 P 55 x H 48



550.CM.01.04_

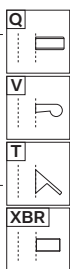

Note: La finitura nero opaco non è in pronta consegna, per la disponibilità contattare l'ufficio commerciale. /Matt black finishes is not in prompt delivery. Please contact the commercial department to check availability.

Mobili di servizio /Service units

L 120 P 60 x H 61,5

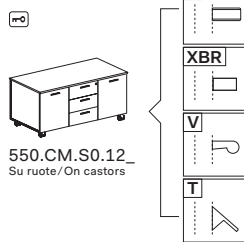

550.CM.S0.12_ Su ruote/On castors

Cassettiere /Pedestals

L 42 P 57 x H 55,5

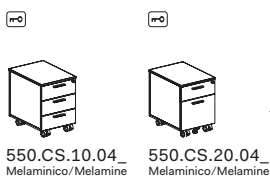

550.CS.10.04_ Melaminico/Melamine

550.CS.20.04_ Melaminico/Melamine

L 32,2 P 54,2 x H 55,6

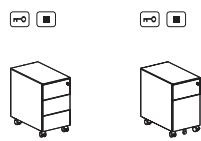

550.CS.1M.03_ Metalliche/Metallic

550.CS.2M.03_ Metalliche/Metallic

L 42,2 P 54,2 x H 55,6

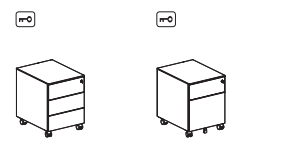

550.CS.1M.04_ Metalliche - Vaschetta porta cancelleria inclusa /Metallic - Stationery tray included

550.CS.2M.04_ Metalliche - Vaschetta porta cancelleria inclusa /Metallic - Stationery tray included

Accessori /Accessories

L 90 P 60 x H 2

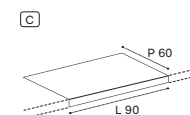

300.AS.01.09_

Note: Per portacancelleria cassette, vedi capitolo DV300-Accessori/For stationary tray, see chapter DV300-Accessories.

Modesty panel - Canalizzazione per tavoli scrivanie/Modesty panel - Wire management for desks

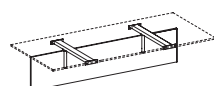

901.MP.01.16_ L 140 (160x80)
901.MP.01.18_ L 160 (180x90)
901.MP.01.20_ L 180 (200x90)
901.MP.11.16_ L 140 (160x160) (L 5 - L 6)

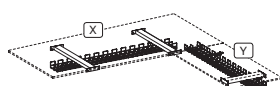

901.AP.15.16_ L 140 (160x80) (X)
901.AP.15.18_ L 160 (180x90) (X)
901.AP.15.20_ L 180 (200x90) (X)
901.AP.24.12_ L 160 (240x120) (X)
901.AP.12.06_ L 140 (120x60) (Y)
901.AP.17.16_ L 140 (160x160) (L 5 - L 6)
901.AP.18.16_ L 140 (160x160) (L 7 - L 8) (O)

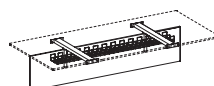



901.MP.06.16_ L 140 (160x80)
901.MP.06.18_ L 160 (180x90)
901.MP.06.20_ L 180 (200x90)
901.MP.12.16_ L 140 (160x160) (L 5 - L 6)

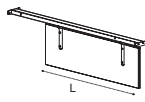
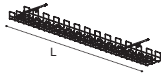
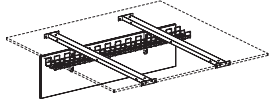

901.AP.32.12_ L 110 (O)
Per piani composti L = 320 cm
/For composed tops W = 320 cm

Modesty panel – Canalizzazione per tavoli scrivanie su mobili di servizio/Modesty panel – wire management for desks on service units

			
901.AP.22.18_L 140 (180x90) (L 1 - L 2) 901.AP.22.20_L 160 (200x90) (L 3 - L 4) 901.AP.17.16_L 140 (160x160) (L 5 - L 6) 901.AP.18.16_L 140 (160x160) (L 7 - L 8) 	901.MP.08.12_L 120 (L 1 - L 2) Per tavoli scrivania L 180 /For desks W 180 901.MP.11.16_L 140 (160x160) (L 5 - L 6) Per tavoli riunione L 160 /For meeting tables W 160 901.MP.09.14_L 140 (L 3 - L 4) Per tavoli scrivania L 200/For desks W 200	901.AP.21.18_ (L 1 - L 2) 901.AP.21.20_ (L 3 - L 4) Da abbinare a modesty panel /To be used with modesty panel	901.MP.12.16_L 140 (160x160) (L 5 - L 6)



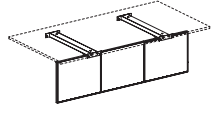
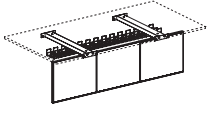



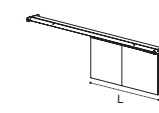
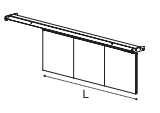
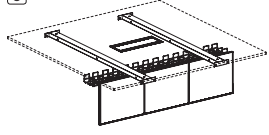



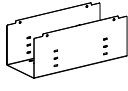

Modesty panel in cuoio per tavoli scrivanie /Leather modesty panel for desks

	
901.MP.01.16_L 140 (160x80) 901.MP.01.18_L 160 (180x90) 901.MP.01.20_L 180 (200x90) 901.MP.11.16_L 140 (160x160) (L 5 - L 6)	901.MP.06.16_L 140 (160x80) 901.MP.06.18_L 160 (180x90) 901.MP.06.20_L 180 (200x90) 901.MP.12.16_L 140 (160x160) (L 5 - L 6)

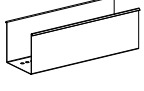
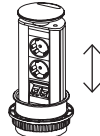
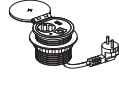
Modesty panel in cuoio per tavoli scrivanie su mobili di servizio /Leather modesty panel for desks on service units

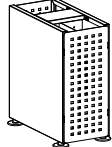
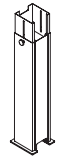
		
901.MP.08.12_L 120 (180x90) (L 1 - L 2)	901.MP.09.14_L 140 (200x90) (L 3 - L 4) 901.MP.11.16_L 140 (160x160) (L 5 - L 6)	901.MP.12.16_L 140 (160x160) (L 5 - L 6)

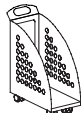
Accessori per canalizzazione – Elettrificazione – Vari/Accessories for wire management – Electrification – Various

						
300.AC.26.02_L 24,5 300.AC.26.03_L 34,5 300.AC.26.04_L 44,5	300.AC.20.02_L 24,5 300.AC.20.03_L 34,5 300.AC.20.04_L 44,5	300.AC.25.02_L 23,5 300.AC.25.03_L 33,5 300.AC.25.04_L 43,5 Marsupio/Basket	300.AP.S1.02_L 20,5 300.AP.S1.03_L 30 300.AP.S1.04_L 42 Per/For top access 300.AC.26_	300.AT.A6.02_L 21 300.AT.A6.03_L 25,5 300.AT.A6.04_L 39	300.AC.38.02_H 2,4	300.AC.67.03 Marsupio per top access 300.AC.38.02 / Basket for top access 300.AC.38.02
		 				
300.AP.T4.01 300.AP.T5.01 – UK  300.AP.T6.01 – US 	300.AP.T8.11 300.AP.T8.14 300.AP.T8.17 300.AP.T8.20	300.AP.T2.01 Ø 8 300.AP.T7.01 Ø 6 300.AP.T8.01 Ø 8	300.AC.16.02_	300.AP.V2.15	300.AP.V1.00	300.AC.06.05_

Bracci porta video/Arms for video support

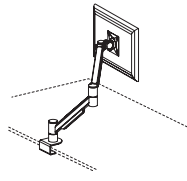
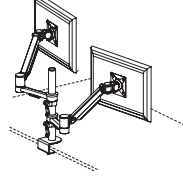
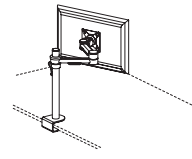
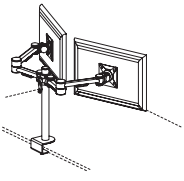
			
300.AC.02.01 Braccio porta video mobile su piano /Dynamic arm for video support on deskbase	300.AC.02.02 Doppio braccio porta video mobile su piano/2 dynamic arms for video support on deskbase	300.AC.01.01 Braccio porta video statico su palo/Static arm for video support on pole	300.AC.01.02 Doppio braccio porta video statico su palo/2 Static arms for video support on pole

Note:

1 Le finiture gres e cuoio non sono in pronta consegna. Per la disponibilità contattare l'ufficio commerciale/Porcelain stoneware and leather finishes are not in prompt delivery. Please contact the commercial department to check availability;

2 Le dimensioni sono espresse in cm – consultare il listino prezzi per le caratteristiche tecniche, i codici degli articoli e delle finiture/Dimensions are stated in cm – for technical characteristics, article code numbers and finishing see price list;

3 Per la scelta dei contenitori e degli accessori vari, consultare il relativo listino o catalogo/To choose storage units and accessories, please check correspondent price list or catalogue;

 Prodotti non in pronta consegna. Per la disponibilità contattare l'ufficio commerciale/Items not in prompt delivery. Please contact the commercial department to check availability;

 Articoli prodotti solo su richiesta/Items produced only on demand;

 Con serratura/With lock;

 Tavoli scrivania con piani composti /Desks with compound worktops.

 Cuoio/Leather;

Planeta DV902

La collezione accogliente e confortevole, si esalta attraverso le svariate finiture cromatiche disponibili, che rendono questa serie attuale e senza tempo. Una linea direzionale elegante e minimale che si distingue per la funzionalità e le diverse profondità dei mobili di servizio portanti.

Cozy and comfortable collection, exalted through a number of available colors and finishes that make this series alive and timeless. This elegant, minimalistic executive range stands out for functionality and for the different depths of the carrying service units.



















Focus e dettagli sulla funzionalità del mobile di servizio in laminato bianco lucido.



Focus and details on the functionalities of the white gloss laminate service unit.











Tavoli / Tables

Piani di lavoro sp. 1.8 cm, in melaminico (*) o laminato (***) con bordi in ABS sp. 0.2 cm /
Worktops 1.8 cm thick, in melamine (*) or laminate (***) with ABS edge-profiles 0.2 cm thick

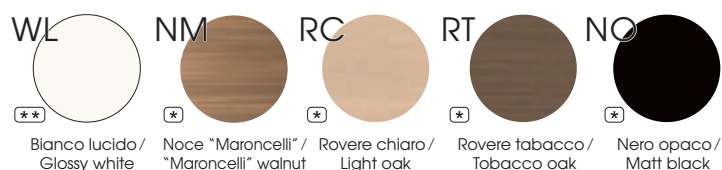

Piani di lavoro sp. 2 cm, in cuoio con cuciture /
Worktop 2 cm thick, in leather with stitches

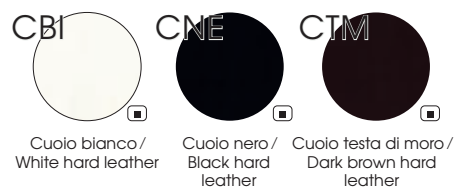

Piani di lavoro sp. 1 cm, in vetro temprato retrolaccato con bordi perimetrali lavorati a filo lucido /
Worktops 1 cm thick, rear-lacquered tempered glass with outer polished edges

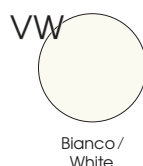

Piani di lavoro sp. 1 cm, in vetro temprato retrolaccato acidato con bordi perimetrali lavorati a filo lucido /
Worktops 1 cm thick, rear-lacquered and acetated tempered glass with outer polished edges



Piano di lavoro in vetro temprato trasparente sp. 0.8 cm, accoppiato con piano in gres porcellanato sp. 0.6 cm /
Worktop in 0.8 cm thick transparent tempered glass, coupled with a 0.6 cm thick porcelain stoneware worktop



Strutture metalliche / Metal structures

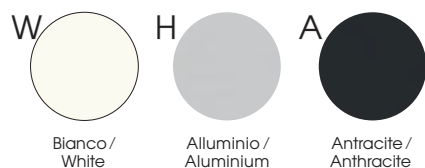

Gambone in metallo con base / Metal column base



Mobili di servizio / Service units

Scocca, ripiani sp. 2.5 cm e ante sp. 1.8 cm, in melaminico (*) o laminato (***) /
Body, shelves 2.5 cm and doors 1.8 cm thick, in melamine (*) or laminate (***)



Note

□ Prodotti non in pronta consegna. Per la disponibilità contattare l'ufficio commerciale / Items not in prompt delivery. Please contact the commercial department to check availability

Tavoli scrivania L 180 con mobile di servizio P 66 (Dx o Sx)/Desks W 180 with service unit D 66 (R or L)

<p>P 180 x H 75</p> <p>Sx/L</p> <p>902.TM.6_18_ Sx/L - Dx/R</p> <p>ⓐ</p> <p>Sx/L</p> <p>902.PM.6_18_ Sx/L - Dx/R</p>	<p>P 180 x H 74</p> <p>Ⓥ</p> <p>Sx/L</p> <p>902.TV.6_18_ Sx/L - Dx/R</p> <p>Ⓥ ⓐ</p> <p>Sx/L</p> <p>902.PV.6_18_ Sx/L - Dx/R</p>	<p>P 180 x H 75</p> <p>ⓐ</p> <p>Sx/L</p> <p>902.TV.6_18_ Sx/L - Dx/R</p> <p>ⓐ ⓐ</p> <p>Sx/L</p> <p>902.PV.6_18_ Sx/L - Dx/R</p>	<p>P 180 x H 75</p> <p>ⓐ</p> <p>Sx/L</p> <p>902.TM.6_18_ Sx/L - Dx/R</p> <p>ⓐ ⓐ</p> <p>Sx/L</p> <p>902.PM.6_18_ Sx/L - Dx/R</p>	<p>Schema delle 3 posizioni di montaggio /Scheme of 3 assembling solutions</p> <p>Soluzione base/Suggested solution</p>	
----------------------------------------------------------------------------------------------------------------------	---------------------------------------------------------------------------------------------------------------------------------	---------------------------------------------------------------------------------------------------------------------------------	---------------------------------------------------------------------------------------------------------------------------------	-------------------------------------------------------------------------------------------------------------------------	--

Tavoli scrivania L 200 con mobile di servizio P 66 (Dx o Sx)/Desks W 200 with service unit D 66 (R or L)

<p>P 180 x H 75</p> <p>Sx/L</p> <p>902.TM.6_20_ Sx/L - Dx/R</p> <p>ⓐ</p> <p>Sx/L</p> <p>902.PM.6_20_ Sx/L - Dx/R</p>	<p>P 180 x H 74</p> <p>Ⓥ</p> <p>Sx/L</p> <p>902.TV.6_20_ Sx/L - Dx/R</p> <p>Ⓥ ⓐ</p> <p>Sx/L</p> <p>902.PV.6_20_ Sx/L - Dx/R</p>	<p>P 180 x H 75</p> <p>ⓐ</p> <p>Sx/L</p> <p>902.TV.6_20_ Sx/L - Dx/R</p> <p>ⓐ ⓐ</p> <p>Sx/L</p> <p>902.PV.6_20_ Sx/L - Dx/R</p>	<p>P 180 x H 75</p> <p>ⓐ</p> <p>Sx/L</p> <p>902.TM.6_20_ Sx/L - Dx/R</p> <p>ⓐ ⓐ</p> <p>Sx/L</p> <p>902.PM.6_20_ Sx/L - Dx/R</p>	<p>Schema delle 3 posizioni di montaggio /Scheme of 3 assembling solutions</p> <p>Soluzione base/Suggested solution</p>	
----------------------------------------------------------------------------------------------------------------------	---------------------------------------------------------------------------------------------------------------------------------	---------------------------------------------------------------------------------------------------------------------------------	---------------------------------------------------------------------------------------------------------------------------------	-------------------------------------------------------------------------------------------------------------------------	--

Tavoli scrivania L 180 con mobile di servizio P 92,5 (Dx o Sx)/Desks W 180 with service unit D 92,5 (R or L)

<p>P 180 x H 75</p> <p>Sx/L</p> <p>902.TM.9_18_ Sx/L - Dx/R</p> <p>ⓐ</p> <p>Sx/L</p> <p>902.PM.9_18_ Sx/L - Dx/R</p>	<p>P 180 x H 74</p> <p>Ⓥ</p> <p>Sx/L</p> <p>902.TV.9_18_ Sx/L - Dx/R</p> <p>Ⓥ ⓐ</p> <p>Sx/L</p> <p>902.PV.9_18_ Sx/L - Dx/R</p>	<p>P 180 x H 75</p> <p>ⓐ</p> <p>Sx/L</p> <p>902.TV.9_18_ Sx/L - Dx/R</p> <p>ⓐ ⓐ</p> <p>Sx/L</p> <p>902.PV.9_18_ Sx/L - Dx/R</p>	<p>P 180 x H 75</p> <p>ⓐ</p> <p>Sx/L</p> <p>902.TM.9_18_ Sx/L - Dx/R</p> <p>ⓐ ⓐ</p> <p>Sx/L</p> <p>902.PM.9_18_ Sx/L - Dx/R</p>	<p>Schema delle 3 posizioni di montaggio /Scheme of 3 assembling solutions</p> <p>Soluzione base/Suggested solution</p>	
----------------------------------------------------------------------------------------------------------------------	---------------------------------------------------------------------------------------------------------------------------------	---------------------------------------------------------------------------------------------------------------------------------	---------------------------------------------------------------------------------------------------------------------------------	-------------------------------------------------------------------------------------------------------------------------	--

Tavoli scrivania L 200 con mobile di servizio P 92,5 (Dx o Sx)/Desks W 200 with service unit D 92,5 (R or L)

<p>P 180 x H 75</p> <p>Sx/L</p> <p>902.TM.9_20_ Sx/L - Dx/R</p> <p>ⓐ</p> <p>Sx/L</p> <p>902.PM.9_20_ Sx/L - Dx/R</p>	<p>P 180 x H 74</p> <p>Ⓥ</p> <p>Sx/L</p> <p>902.TV.9_20_ Sx/L - Dx/R</p> <p>Ⓥ ⓐ</p> <p>Sx/L</p> <p>902.PV.9_20_ Sx/L - Dx/R</p>	<p>P 180 x H 75</p> <p>ⓐ</p> <p>Sx/L</p> <p>902.TV.9_20_ Sx/L - Dx/R</p> <p>ⓐ ⓐ</p> <p>Sx/L</p> <p>902.PV.9_20_ Sx/L - Dx/R</p>	<p>P 180 x H 75</p> <p>ⓐ</p> <p>Sx/L</p> <p>902.TM.9_20_ Sx/L - Dx/R</p> <p>ⓐ ⓐ</p> <p>Sx/L</p> <p>902.PM.9_20_ Sx/L - Dx/R</p>	<p>Schema delle 3 posizioni di montaggio /Scheme of 3 assembling solutions</p> <p>Soluzione base/Suggested solution</p>	
----------------------------------------------------------------------------------------------------------------------	---------------------------------------------------------------------------------------------------------------------------------	---------------------------------------------------------------------------------------------------------------------------------	---------------------------------------------------------------------------------------------------------------------------------	-------------------------------------------------------------------------------------------------------------------------	--

Note:

- 1 Le finiture gres e cuoio non sono in pronta consegna. Per la disponibilità contattare l'ufficio commerciale/ Porcelain stoneware and leather finishes are not in prompt delivery. Please contact the commercial department to check availability;
- 2 I tavoli possono essere montati sui mobili di servizio (destri o sinistri) scegliendo tra 3 diverse posizioni. Per ogni soluzione modesty panel è disponibile la dimensione del corrispondente modesty panel (vedi relativa quota indicata con MP) mentre il canale passacavi si ordina secondo la lunghezza del piano di

- lavoro utilizzato/ The desks can be mounted on service units (right or left hand) in 3 different positions. Find the proper modesty panel to match the chosen composition (see sizes indicated with MP), while the cable channels change according to the size of the worktop;
- 3 Le dimensioni sono espresse in cm - consultare il listino prezzi per le caratteristiche tecniche, i codici degli articoli e delle finiture/Dimensions are stated in cm - for technical characteristics, article code numbers and finishing see price list;

- Prodotti non in pronta consegna. Per la disponibilità contattare l'ufficio commerciale/ Items not in prompt delivery. Please contact the commercial department to check availability;
- ⓐ Articolo subordinato a commessa minima. Previsto anche nella versione con fori e tappi passacavi (Optional - Vedere listino) /Item tied-up to a minimum quantity production. Also foreseen in a version including holes and out-let lids. (Optional - Refer to price list);
- Ⓥ Vetro/Glass; ⓐ Cuoio/Leather; ⓐ Gres/Gres.

Tavoli per composizioni/Desks for compositions

P 90 x H 75 V	P 90 x H 74 V	P 90 x H 75 G ■	P 90 x H 75 C ■
902.TI.15.18_L 180 902.TI.15.20_L 200	902.TV.11.18_L 180 902.TV.11.20_L 200	902.TV.11.18_L 180 902.TV.11.20_L 200	902.TI.15.18_L 180 902.TI.15.20_L 200

Tavoli riunione/Meeting tables

Ø 100 x H 74,5 V ■ HA	V H	Ø 100 x H 75 G ■ HA	G ■ H	L 100 P 100 x H 75	L 100 P 100 x H 75 C ■	L 160 P 160 x H 75	L 160 P 160 x H 75 C ■
902.TV.14.10_	902.TV.15.10_	902.TV.14.10_	902.TV.15.10_	902.TR.42.10_	902.TR.42.10_	902.TR.43.16_	902.TR.43.16_

L 240 P 120 x H 75	L 240 P 120 x H 74,5 V	L 240 P 120 x H 74,5 G ■	L 240 P 120 x H 75 C ■
902.TR.41.24_	902.TV.36.24_	902.TV.36.24_	902.TR.41.24_

Tavoli riunione componibili con gambe centrali rientrate/Modular meeting tables with central recessed legs

L 320 P 160 x H 75	L 320 P 160 x H 75 C ■	L 480 P 160 x H 75	L 480 P 160 x H 75 C ■
902.TR.32.32_	902.TR.32.32_	902.TR.32.48_	902.TR.32.48_

Elementi per tavoli riunioni componibili con gambe centrali rientrate/Modular elements for compound meeting tables with central recessed legs

L 160 P 160 x H 75	L 160 P 160 x H 75 C ■
902.TR.32.16_	902.TR.32.16_

Modesty panel – canalizzazione per tavoli scrivanie su mobili di servizio/Modesty panel – wire management for desks on service units

Per tavoli L 180/For desks W 180			Per tavoli L 200/For desks W 200		
902.AP.15.16_L 140 (L 180)	902.MP.08.10_L 100 (L1-L7)	902.MP.13.10_L 100 (L1-L7)	902.AP.15.18_L 160 (L 200)	902.MP.09.12_L 120 (L4-L10)	902.MP.14.12_L 120 (L4-L10)
	902.MP.08.12_L 120 (L8)	902.MP.13.12_L 120 (L8)		902.MP.09.14_L 140 (L11)	902.MP.14.14_L 140 (L11)
902.AP.21.18_L 140	902.MP.08.13_L 130 (L2)	902.MP.13.13_L 130 (L2)		902.MP.09.15_L 150 (L5)	902.MP.14.15_L 150 (L5)
	902.MP.08.14_L 140 (L3-L9)	902.MP.13.14_L 140 (L3-L9)		902.MP.09.16_L 160 (L6-L12)	902.MP.14.16_L 160 (L6-L12)

Modesty panel in cuoio /Leather modesty panel

Per tavoli L 180/For desks W 180			Per tavoli L 200/For desks W 200		Accessori /Accessories
902.MP.08.10_L 100 (L1-L7)	902.MP.08.14_L 140 (L3-L9)		902.MP.09.12_L 120 (L4-L10)	902.MP.09.14_L 140 (L11)	
902.MP.08.12_L 120 (L8)				902.MP.09.15_L 150 (L5)	
902.MP.08.13_L 130 (L2)				902.MP.09.16_L 160 (L6-L12)	

Canalizzazione per tavoli scrivanie/Wire management for desks

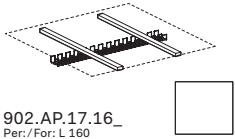

902.AP.17.16_
Per./For: L 160

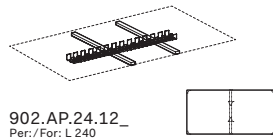

902.AP.24.12_
Per./For: L 240

Cassettiere/Pedestals

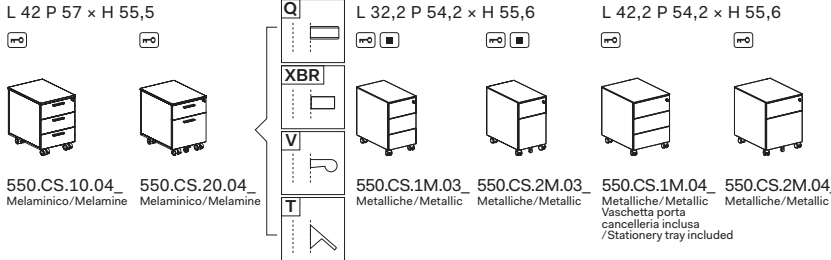

[Note:] Per portacancelleria cassetti, vedi capitolo DV300-Accessori/For stationary tray, see chapter DV300-Accessories.

Mobili di servizio e cassettera interna /Service unit and internal pedestals

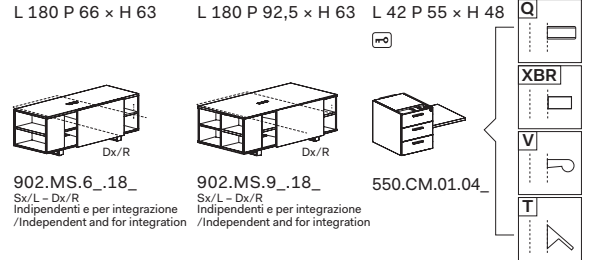

[Note:] La finitura nero opaco non è in pronta consegna, per la disponibilità contattare l'ufficio commerciale. /Matt black finishes is not in prompt delivery. Please contact the commercial department to check availability.

Accessori per canalizzazione – Elettrificazione – Vari/Accessories for wire management – Electrification – Various

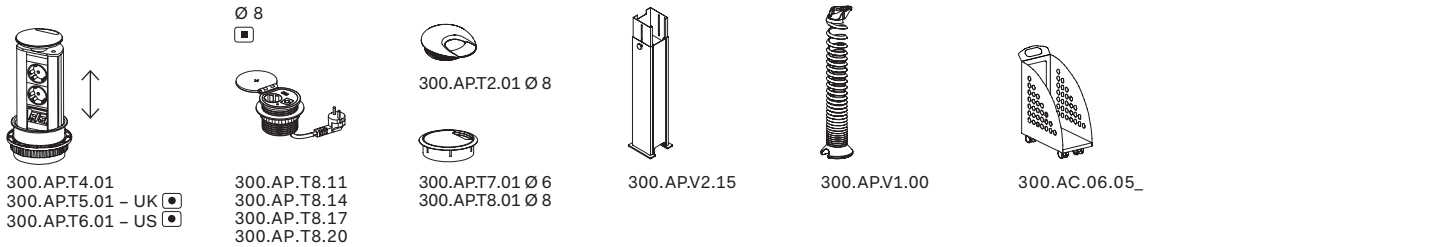
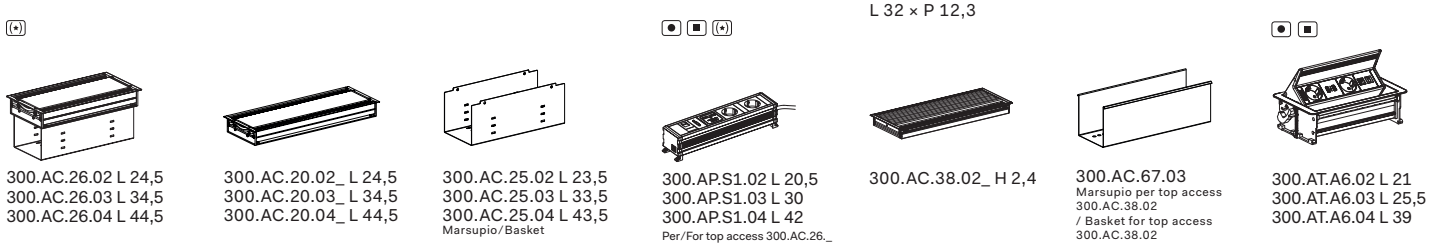

Bracci porta video/Arms for video support

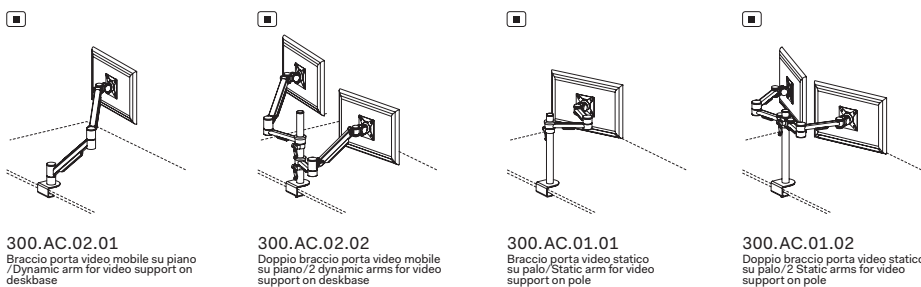

Note:

- 1 Le finiture gres e cuoio non sono in pronta consegna. Per la disponibilità contattare l'ufficio commerciale/ Porcelain stoneware and leather finishes are not in prompt delivery. Please contact the commercial department to check availability;
- 2 Per la scelta dei contenitori e degli accessori vari, consultare il relativo listino o catalogo/To choose storage units and accessories, please check correspondent price list or catalogue;
- 3 Le dimensioni sono espresse in cm – consultare il listino prezzi per le caratteristiche tecniche, i codici degli articoli e delle finiture/Dimensions are stated in cm – for technical characteristics, article code numbers and finishing see price list;

- Prodotti non in pronta consegna. Per la disponibilità contattare l'ufficio commerciale/Items not in prompt delivery. Please contact the commercial department to check availability;
- Articoli prodotti solo su richiesta/Items produced only on demand;
- HA Gambone in alluminio anodizzato / Metal column made in "Anodized" aluminium;
- H Gambone verniciato a polveri in bianco, alluminio o antracite / Metal column electrostatic painted in white, aluminum or anthracite;

- G Gres/Gres;
- C Cuoio/Leather;
- V Vetro/Glass;
- Con serratura/With lock;

Oxford

DV910

È un sistema direzionale composto da una ampia gamma di elementi di arredo in grado di risolvere le esigenze progettuali più svariate. L'effetto minimale viene stemperato e nel contempo valorizzato dalle combinazioni fra le finiture.

It is an executive system composed of a wide range of furnishing elements able to solve the most varied design needs. The minimal effect is softened and at the same time enhanced by the combinations of finishes.











Executives













Executives

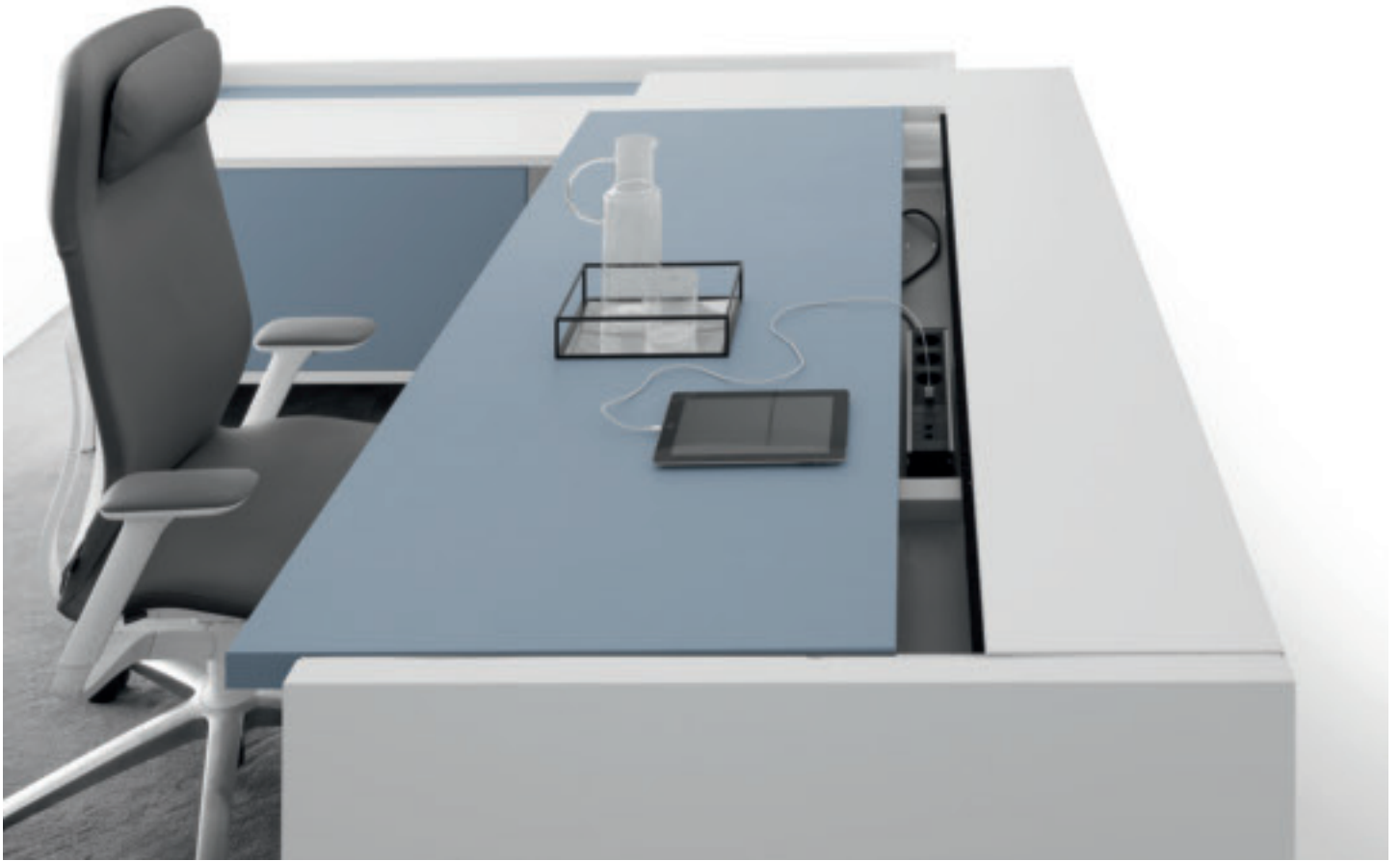

Focus e dettagli sulla funzionalità del piano scrivania con apertura a scorrimento per la canalizzazione.

Focus and details on the functionality of the worktop with sliding opening for channeling.











Focus e dettagli sulla funzionalità del contenitore multifunzione con i suoi cassetti, il led e la schiena pinnabile.

Focus and details on the functionality of the multifunctional container with its drawers, the led and pinnable back.





























Dettagli del tavolo Oxford, regolabile elettrico / Details of the Oxford table, electric adjustable



Da H. 77 ÷ 142 cm / From H. 30 5/16" ÷ 55 14/16"

Tavoli / Tables

Piani di lavoro sp. 3.8 cm, in melaminico con bordi in ABS sp. 0.2 cm / Worktops 3.8 cm thick, in melamine with ABS edge-profiles 0.2 cm thick

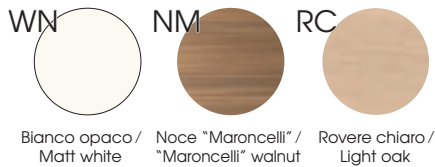

Piano di lavoro effetto pelle sp. 3.8 cm / Leather effect worktop 3.8 cm thick

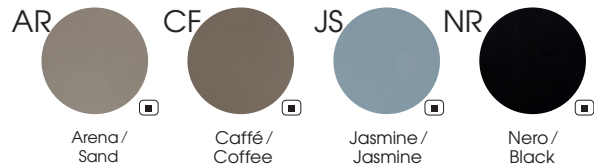

Piano frontale dei piani composti - Gambe pannellate e struttura in melaminico sp. 3.8 cm / Frontal melamine worktops (for compound worktops) - Melamine panelled legs and frame 3.8 cm thick

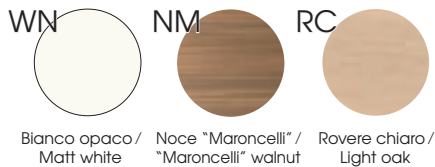

Modesty panel in melaminico sp. 2.5 cm / Melamine modesty panel 2.5 cm thick

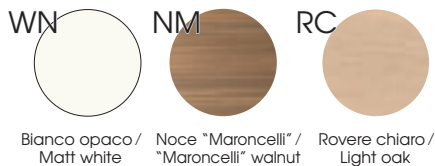

Modesty panel effetto pelle sp. 2.5 cm / Leather effect modesty panel 2.5 cm thick

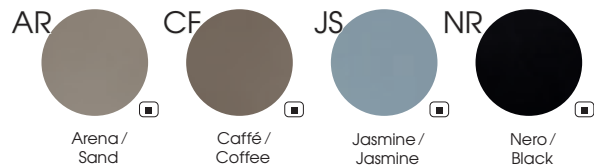

Contenitori multifunzione e Mobili di servizio / Multi - purpose storage unit and Service units

Scocche in melaminico / Melamine shells

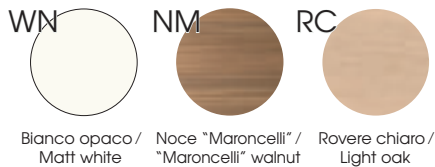

Ante mobile di servizio, contenitore multifunzione e frontali cassetiera sp. 1.8 cm - Sportello apribile mobile di servizio sp. 2.5 cm / Service unit, multi-purpose unit doors and drawers front panel 1.8 cm thick - Service unit flip door 2.5 cm thick

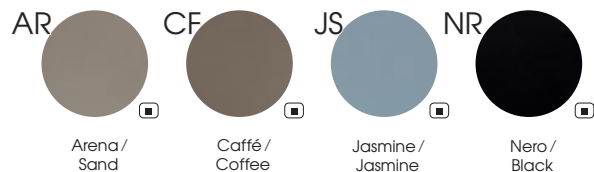
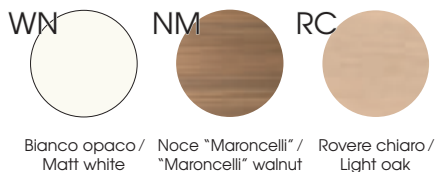

Schiena pinnabile in tessuto 100% poliestere Trevira CS - JET Bioactive / Pinnable back panel with 100% polyester Trevira CS - JET Bioactive fabric

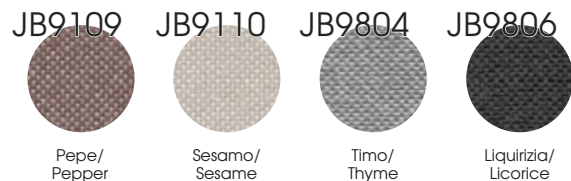

Note

☐ Prodotti non in pronta consegna. Per la disponibilità contattare l'ufficio commerciale / Items not in prompt delivery. Please contact the commercial department to check availability;

Tavoli scrivania H 75/Desks tables H 75

P 90 x H 75
CM

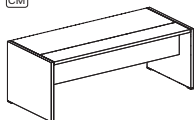

910.TS.68.20_ L 204
910.TS.68.22_ L 224

P 90 x H 75
CM

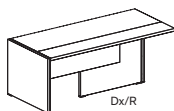

910.TS.59.20_ L 200 Dx/R - Sx/L
910.TS.59.22_ L 220 Dx/R - Sx/L

Tavoli scrivania H 75 su allungo H 71/
Tables H 75 on lateral extension H 71

P 210 x H 75
CM

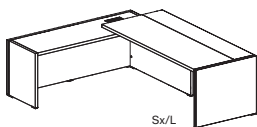

910.TM.42.23_ L 230 Dx/R - Sx/L
910.TM.42.25_ L 250 Dx/R - Sx/L

Tavoli scrivania con allungo H 75/
Tables with lateral extension H 75

P 210 x H 75
CM

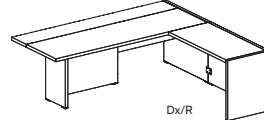

910.TM.47.20_ L 200 Dx/R - Sx/L
910.TM.47.22_ L 220 Dx/R - Sx/L



Tavoli scrivania H 75 con mobile di servizio H 65 con anta scorrevole/
Tables H 75 with service unit H 65 with sliding door

P 210 x H 75
CM

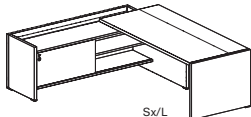

910.TM.32.23_ L 230 Dx/R - Sx/L
910.TM.32.25_ L 250 Dx/R - Sx/L

CMS

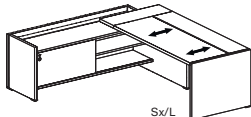

910.TM.33.23_ L 230 Dx/R - Sx/L
910.TM.33.25_ L 250 Dx/R - Sx/L

Tavolini caffè/Coffee tables

P 60 x H 45



Gamba a "X"
/"X" shaped leg



Gamba a "L"
/"L" shaped leg

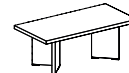

Gamba a "X"
/"X" shaped leg

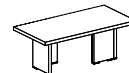

Gamba a "L"
/"L" shaped leg

910.TT.03.06_ L 60

910.TT.03.12_ L 120

Tavoli riunione/Meeting tables

L 140 P 140 x H 75

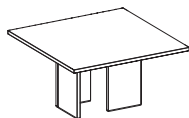

910.TR.38.14_

L 240 P 120 x H 75

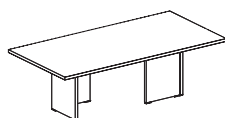

910.TR.41.24_

Raccordo/Connection element

Ø 120 x H 75

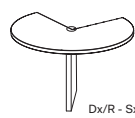

910.PE.01.12_

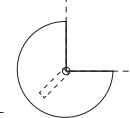

Tavoli scrivania regolabili in altezza a tre stadi elettricamente da H 77÷142 cm
/Desks adjustable in H electrical at three stages from H 77 to H 142 cm

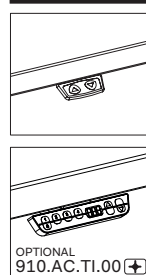

P 90 x H 77 ÷ 142
CM

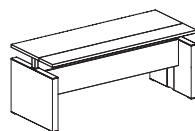

910.TS.69.20_ L 200
910.TS.69.22_ L 220

P 214 x H 77 ÷ 142
CM

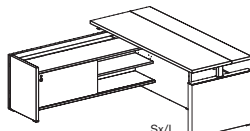

910.TM.34.20_ L 200 Dx/R - Sx/L
910.TM.34.22_ L 220 Dx/R - Sx/L

P 214 x H 77 ÷ 142
CM

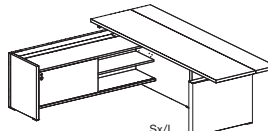

910.TM.34.27_ L 270 Dx/R - Sx/L

Catena passacavi
/Cable management chain

L 120 P 5 x H 3



910.AP.10.00

Note:

1 Le finiture in melaminico effetto pelle non sono in pronta consegna. Per la disponibilità contattare l'ufficio commerciale./The melamine leather-effect finishes are not in prompt delivery. Please contact the commercial department to check availability;

2 Le dimensioni sono espresse in cm - consultare il listino prezzi per le caratteristiche tecniche, i codici degli articoli e delle finiture./Dimensions are stated in cm - for technical characteristics, article code numbers and finishing see price list;

3 Sotto i piani in allungo delle composizioni con il mobile multifunzione è possibile integrare le cassette 910.EC.03... e 910.EC.04.04 /It is possible to integrate 910.EC.03... and 910.EC.04.04 pedestals under the extension worktops of the compositions with multi-purpose storage unit.

4 Prodotti non in pronta consegna. Per la disponibilità contattare l'ufficio commerciale./Items not in prompt delivery. Please contact the commercial department to check availability;

CM Piano composto/Compound worktop.

CMS Piano composto sliding/Sliding compound worktop.

5 Tastierino per regolazione altezza piano con memorie / Control pad with memories for height adjustable worktop.

6 Con serratura/With lock.

Contenitore multifunzione / Multi-purpose storage unit

P 60 x H 190

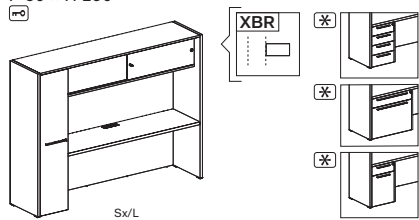

910.HC.01.25_ L 250 Dx/R - Sx/L

Composizioni con piano composto / Compositions with compound worktop

L 250 P 266 x H 190

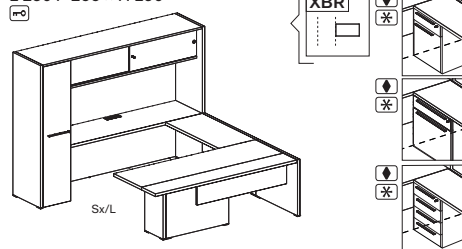

910.CM.P2.20_ Dx/R - Sx/L
910.CM.P2.22_ Dx/R - Sx/L

Accessori contenitore multifunzione / Accessories multi-purpose storage unit

L 200 P 2,5 x H 69,5

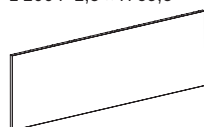

910.AC.SC.20_ Schiena pinnabile per mobile multifunzione / Pinnable back panel for multi-purpose storage unit

L 200 P 3 x H 1,5

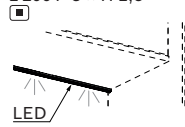

910.LL.02.20 Barra led (optional) per contenitore multifunzione / LED spotlight (optional) for multi-purpose storage unit

Cassettiere per contenitori / Pedestals for wardrobe

P 58 x H 71

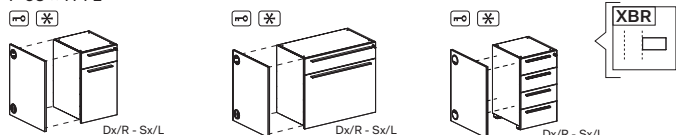

910.EC.01.04_ L 43,5

910.EC.01.08_ L 82

910.EC.02.04_ L 43,5

Cassettiere per allunghi / Pedestals for extension tables

P 56 x H 71

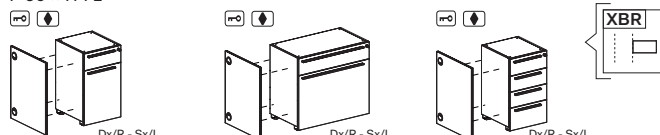

910.EC.03.04_ L 43,5

910.EC.03.08_ L 82

910.EC.04.04_ L 43,5

Cassetti metallici / Metallic drawer

L 86 P 26 x H 7,5

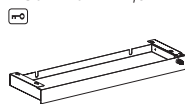

910.CA.01.09 Cassetto metallico per mobile di servizio / Metallic drawer for service unit

L 32,5 P 52 x H 7



910.CA.01.04 Cassetto metallico sotto piano / Under top metallic drawer

L 32,5 P 52 x H 14,5

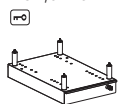

910.CA.01.05 Cassetto metallico per tavolo regolabile elettrico / Metallic drawer for Desks adjustable in H electrical

L 32 P 10 x H 7

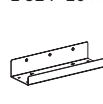

910.AP.33.03 Vassoio per mobile di servizio / Tray for service unit

L 87 P 35 x H 9

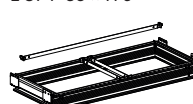

910.CS.A5.08 Portacartelle estraibile / Draw-out frame for folders

L 82 P 34,5 x H 18



910.CS.A6.08 Box metallico per portacartelle estraibile / Metallic box for draw-out frame for folders

Cassettiere su ruote / Pedestals on castors

L 42 P 57 x H 55,5



550.CS.10.04_ Melaminico /Melamine

550.CS.20.04_ Melaminico /Melamine

L 32,2 P 54,2 x H 55,6

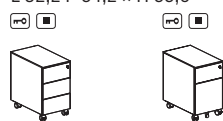

550.CS.1M.03_ Metalliche /Metallic

550.CS.2M.03_ Metalliche /Metallic

L 42,2 P 54,2 x H 55,6

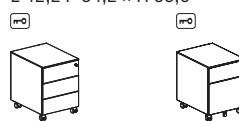

550.CS.1M.04_ Metalliche - Vaschetta porta cancelleria inclusa /Metallic - Stationery tray included

550.CS.2M.04_ Metalliche - Vaschetta porta cancelleria inclusa /Metallic - Stationery tray included

Note: Per portacancelleria cassetti, vedi capitolo DV300-Accessori / For stationary tray, see chapter DV300-Accessories.

Note:

1 Le finiture in melaminico effetto pelle non sono in pronta consegna. Per la disponibilità contattare l'ufficio commerciale; The melamine leather-effect finishes are not in prompt delivery. Please contact the commercial department to check availability;

■ Prodotti non in pronta consegna. Per la disponibilità contattare l'ufficio commerciale/Items not in prompt delivery. Please contact the commercial department to check availability;







☑ Con serratura/With lock.

☒ Sotto i piani dei contenitori multifunzione è possibile integrare le cassettiere 910.EC.01.__ e 910.EC.02.04 /It is possible to integrate 910.EC.01.__ and 910.EC.02.04 pedestals under the worktops of the multi-purpose storage unit.

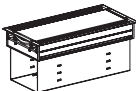

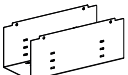

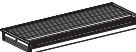



☒ Sotto i piani in allungo delle composizioni con il mobile multifunzione è possibile integrare le cassettiere 910.EC.03.__ e 910.EC.04.04 /It is possible to integrate 910.EC.03.__ and 910.EC.04.04 pedestals under the extension worktops of the compositions with multi-purpose storage unit.

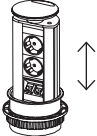

Accessori per canalizzazione – Elettrificazione – Vari/Accessories for wire management – Electrification – Various

L 32 x P 12,3

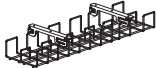

 300.AC.26.02 L 24,5 300.AC.26.03 L 34,5 300.AC.26.04 L 44,5	 300.AC.20.02_L 24,5 300.AC.20.03_L 34,5 300.AC.20.04_L 44,5	 300.AC.25.02 L 23,5 300.AC.25.03 L 33,5 300.AC.25.04 L 43,5 Marsupio/Basket	 300.AP.S1.02 L 20,5 300.AP.S1.03 L 30 300.AP.S1.04 L 42 Per/For top access 300.AC.26_	 300.AC.37.02 L 22	 300.AC.38.03_H 3	 300.AC.67.03 Marsupio per top access 300.AC.38.03 / Basket for top access 300.AC.38.03
-------------------------------------------------------------------------------------------------------------------------------------------------------	--------------------------------------------------------------------------------------------------------------------------------------------------------	---------------------------------------------------------------------------------------------------------------------------------------------------------------------------	-------------------------------------------------------------------------------------------------------------------------------------------------------------------------------------	---------------------------------------------------------------------------------------------------------	---------------------------------------------------------------------------------------------------------	-------------------------------------------------------------------------------------------------------------------------------------------------------------------------------------------

Ø 8

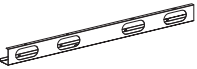
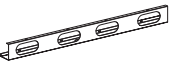
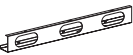
 300.AP.T4.01 300.AP.T5.01 - UK  300.AP.T6.01 - US 	 300.AP.T8.11 300.AP.T8.14 300.AP.T8.17 300.AP.T8.20	 300.AP.T7.01 Ø 6 300.AP.T8.01 Ø 8	 300.AT.A6.02 L 21 300.AT.A6.03 L 25,5 300.AT.A6.04 L 39	 300.AP.V1.00	 300.AC.06.05_
----------------------------------------------------------------------------------------------------------------------------------------------------------------------------------------------------------------------------------------------------------------------------------------------------------------	---------------------------------------------------------------------------------------------------------------------------------------------------	---------------------------------------------------------------------------------------------------------------------------	----------------------------------------------------------------------------------------------------------------------------------------------------	---------------------------------------------------------------------------------------------------	------------------------------------------------------------------------------------------------------

 910.AP.08.06_H 58	 300.AP.15.10 L 100 300.AP.15.11 L 110 300.AP.15.14 L 140 300.AP.15.16 L 160	 910.AP.01.16 L 165 910.AP.01.18 L 185 Canalina per tavoli scrivania /Desks wire management	 910.AP.09.19 L 199 Canalina per contenitore /Wardrobe wire management	 910.AP.09.15 L 155 Canalina per contenitore con cassetiera L 40/Wardrobe with drawer 40 D. wire management	 910.AP.09.11 L 116,5 Canalina per contenitore con cassetiera L 80/Wardrobe with drawer 80 D. wire management
-------------------------------------------------------------------------------------------------------	---------------------------------------------------------------------------------------------------------------------------------------------------------------------------	------------------------------------------------------------------------------------------------------------------------------------------------------------------------------------------	------------------------------------------------------------------------------------------------------------------------------------------------------------------	------------------------------------------------------------------------------------------------------------------------------------------------------------------------------------------------------------	--------------------------------------------------------------------------------------------------------------------------------------------------------------------------------------------------------------

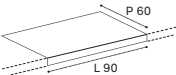
L 90 P 60 x H 2

 300.AS.01.09_	 503.CS.P1.00 L 33 503.CS.P2.00 L 39
-----------------------------------------------------------------------------------------------------	-------------------------------------------------------------------------------------------------------------------------------

Bracci porta video/Arms for video support

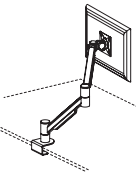
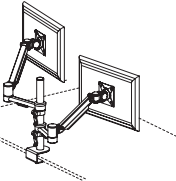
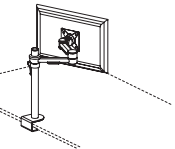
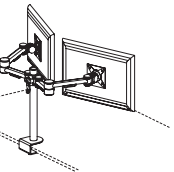
 300.AC.02.01 Braccio porta video mobile su piano /Dynamic arm for video support on deskbase	 300.AC.02.02 Doppio braccio porta video mobile su piano/2 dynamic arms for video support on deskbase	 300.AC.01.01 Braccio porta video statico su palo/Static arm for video support on pole	 300.AC.01.02 Doppio braccio porta video statico su palo/2 Static arms for video support on pole
--------------------------------------------------------------------------------------------------------------------------------------------------------------------------------------------	------------------------------------------------------------------------------------------------------------------------------------------------------------------------------------------------------	---------------------------------------------------------------------------------------------------------------------------------------------------------------------------------------	--------------------------------------------------------------------------------------------------------------------------------------------------------------------------------------------------

Note:

1 Le finiture in melaminico effetto pelle non sono in pronta consegna. Per la disponibilità contattare l'ufficio commerciale;/The melamine leather-effect finishes are not in prompt delivery. Please contact the commercial department to check availability;

2 Le dimensioni sono espresse in cm – consultare il listino prezzi per le caratteristiche tecniche, i codici degli articoli e delle finiture;/Dimensions are stated in cm – for technical characteristics, article code numbers and finishing see price list;

3 Per la scelta dei contenitori e degli accessori vari, consultare il relativo listino o catalogo;/To choose storage units and accessories, please check correspondent price list or catalogue;

4 Prodotti non in pronta consegna. Per la disponibilità contattare l'ufficio commerciale;/Items not in prompt delivery. Please contact the commercial department to check availability;

5 Articoli prodotti solo su richiesta;/Items produced only on demand;

dvo_

DVO S.R.L. con unico socio
Via XX Settembre, 272
Casella Postale n. 65
U.P. Roveredo in Piano
33080 Roveredo in Piano (PN)
Italy

Tel. +39 0434 386 111
Fax +39 0434 386 112
www.dvo.it
info@dvo.it

Graphic Design
dvo_uff_mkt

Print
Grafiche Antiga

Printed in Italy
Issue 01
December 2021



**Foto e testi copyright
DVO non riproducibili.
La venditrice si riserva
la facoltà di apportare
al prodotto eventuali
modifiche tecniche,
dimensionali ed estetiche
in qualsiasi momento
senza preavviso.**

Pictures and text are
DVO copyright, duplicate
forbidden. The selling
Company reserves the
right to introduce changes
to products regarding
sizes and aesthetical
or technical aspects at
any timewithout notice.



DVO S.R.L. - AZIENDA CERTIFICATA / CERTIFIED COMPANY



Richiedi i prodotti certificati FSC® / Request for FSC® certified products

Il marchio della
gestione forestale
responsabile

dvo_

DVO S.R.L. con unico socio
Via XX Settembre, 272
Casella Postale n. 65
U.P. Roveredo in Piano
33080 Roveredo in Piano (PN)
Italy

Tel. +39 0434 386 111
Fax +39 0434 386 112
www.dvo.it
info@dvo.it

